

6-SOURCE 6-ZONE DISTRIBUTED AUDIO SYSTEM

Model: DAX66 User Manual

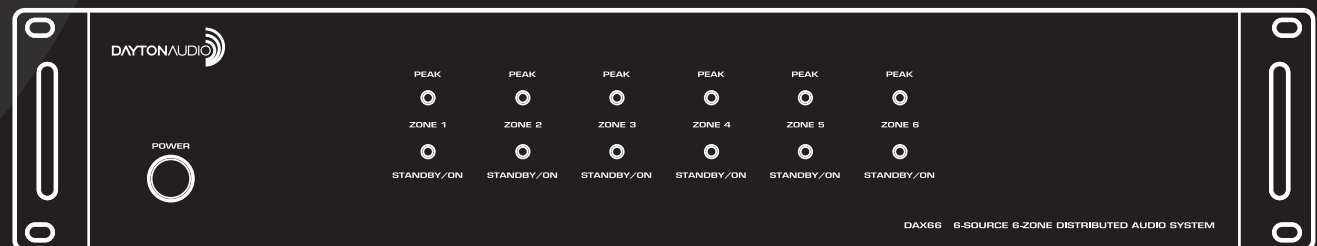

SAFETY INSTRUCTIONS

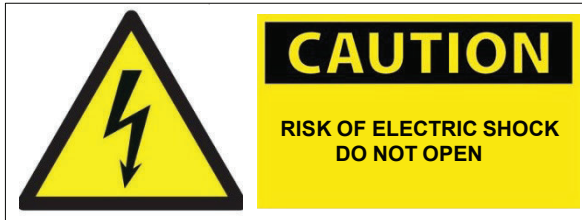

WARNING! TO REDUCE THE RISK OF FIRE OR ELECTRIC SHOCK, DO NOT EXPOSE THIS APPLIANCE TO RAIN OR MOISTURE.

CAUTION! TO REDUCE THE RISK OF SHOCK, DO NOT REMOVE THE COVER, NO USER SERVICABLE PARTS INSIDE. REFER SERVICE TO A DAYTON AUDIO AUTHORIZED DEALER.

IMPORTANT SAFETY INSTRUCTIONS

- Read and keep these instructions.
 - Heed all warnings and follow all instructions contained within this manual.
 - Do not use this unit near water.
 - Clean only with dry cloth.
 - Do not block any ventilation openings. Install in accordance with the manufacturer's instructions.
 - Do not install near any heat sources such as radiators, heat registers, stoves, or other apparatus (including amplifiers) that produce heat.
 - Do not defeat the safety purpose of the polarized or grounding-type plug. A polarized plug has two blades with one wider than the other. A grounding type plug has two blades and a third grounding prong. The wide blade or the third prong are provided for your safety. If the provided plug does not fit into your outlet, consult an electrician for replacement of the obsolete outlet.
 - Protect the power cord from being walked on or pinched particularly at plugs, convenience receptacles, and the point where they exit from the unit.
 - Only use attachments/accessories specified by the manufacturer.
 - Unplug this unit during lightning storms or when unused for long periods of time.
 - Refer all servicing to qualified service personnel. Servicing is required when the unit has been damaged in any way, such as when the power-supply cord or plug is damaged, liquid has been spilled, or objects have fallen into the unit, the unit has been exposed to rain or moisture, does not operate normally, or has been dropped.
 - Operate the unit only with the voltage specified on the rear. Fire and/or electric shock may result if a higher voltage is used.
 - Do not modify, kink, or cut the power cord. Do not place the power cord in close proximity to heaters and do not place heavy objects on the power cord and/or the unit itself, doing so may result in fire or electrical shock.
 - Do not touch the speaker terminals as electric shock may result.
 - Ensure that the safety ground terminal is connected to a proper ground. Never connect the ground to a gas pipe, as a severe explosion and/or fire may result.
 - Be sure the installation of this product is stable, avoid unlevel surfaces as the product may fall and cause injury, property damage, electrocution and/or fire.
 - Note that when the unit is turned off, it is not completely disconnected from the AC power outlet. Do not open the cover.
- REFER ALL SERVICE TO A QUALIFIED SERVICE TECHNICIAN**

PRODUCT OVERVIEW

Congratulations on your purchase of the Dayton Audio DAX66 6-Source 6-Zone Distributed Audio System. You have chosen a unit that provides the ultimate audio control in six stereo zones (expandable to 18 stereo zones). The DAX66 is a true matrix audio system that delivers an extensive list of features for professional and residential installations. The DAX66 was designed for ease of installation by the integrator, and to be simple to operate for the user.

The DAX66 provides six analog line inputs, and one Toslink S/PDIF digital audio input. Play music from CD, DVD, satellite or cable box, PC, or personal audio device. The RS232 interface allows an automation system to manage and control the DAX66. Built-in IR repeater provides a path to control source devices through the IR target in the keypad. Operates with 4 ~ 8 ohm speakers in stereo mode, 8 ohm speakers in bridged mono mode, and provides a generous level of output power.

Please read and retain this manual to get the most from your Dayton Audio DAX66 6-Source 6-Zone Distributed Audio System.

The DAX66 kit includes the following parts:

1. 1 x Master Controller/Amplifier
2. 6 x Keypad Controllers
3. 1 x In-Wall Keypad Hub Connection Plate
4. 1 x Infrared Remote Control
5. 1 x Expansion Ribbon Cable
6. 1 x Rack Mounting Kit
7. 1 x Installation Guide/Operation Manual

DAX66 MASTER CONTROLLER / AMPLIFIER — FRONT

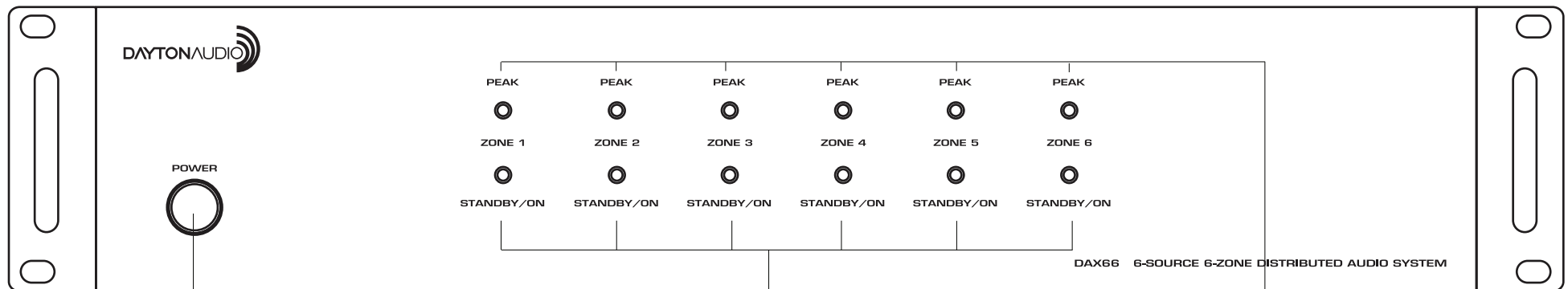

Power On/Off/Standby
Press the power button to turn the system on and place all zones in stand-by mode.

Standby/Zone ON LED
All zones are in standby mode until activated by a keypad. A BLUE LED indicates a zone is in standby mode, a WHITE LED indicates that a zone is active.

Peak LED
The PEAK LED indicates a connected source level is too high. If the PEAK LED emits a flashing or steady RED light, reduce the zone input or output level.

DAX66 MASTER CONTROLLER / AMPLIFIER — REAR PANEL

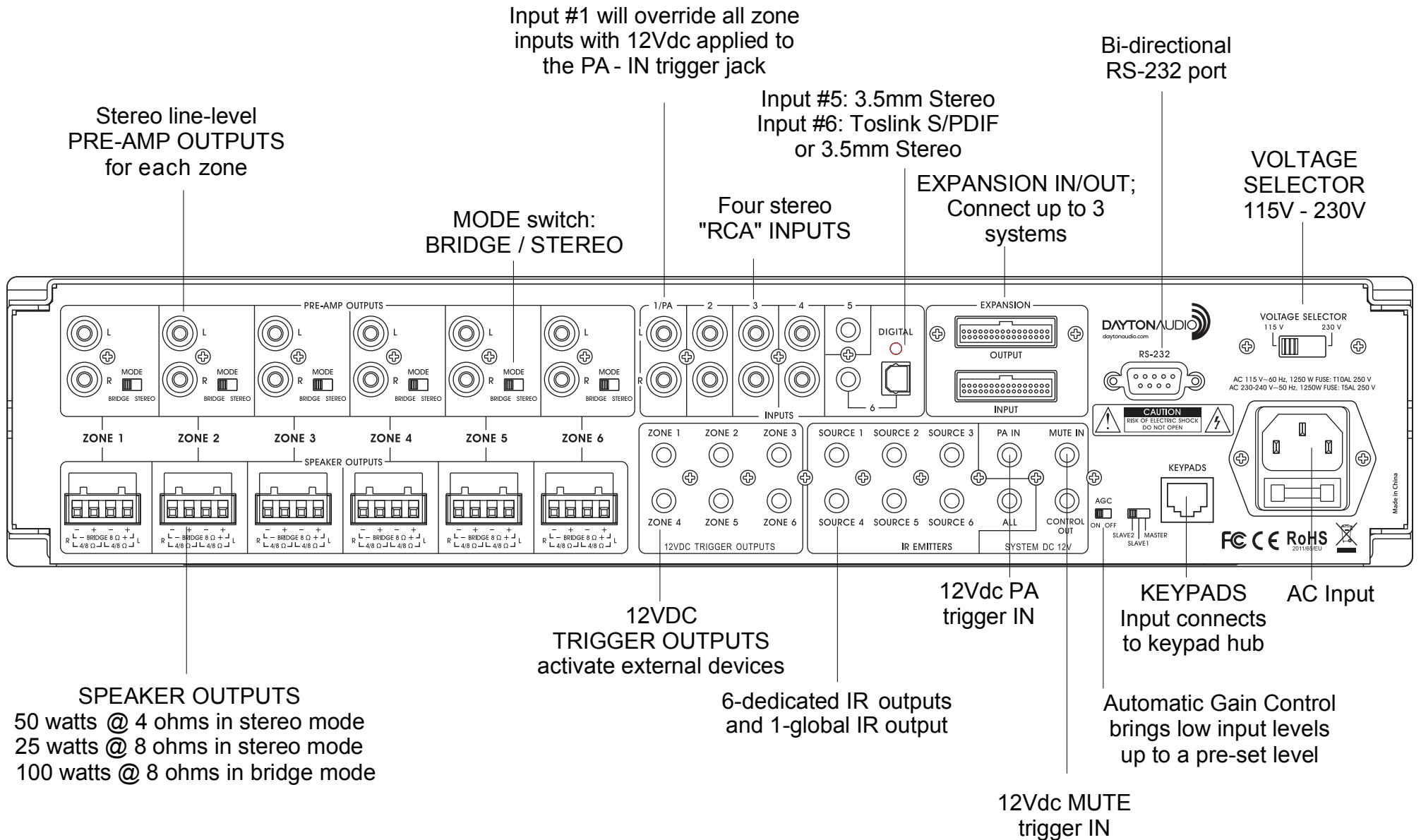

DAX66 KEYPAD FEATURES

The DAX66 keypad is designed for ease of use with a maximum ability to control sound. Soft-touch backlit buttons and a backlit LED display provide convenient control of the zone; ON/OFF, source 1 ~ 6 selection, volume, treble, and bass. A built-in IR target or external IR target connected to the EXT-IR terminals on the rear of the keypad, relay commands to the DAX66 master controller. Dedicated IR output jacks provide remote source control of the source equipment. The built-in IR target also provides complete zone control when using the DAXRC infrared remote control. One DAXRC is included with each system, and additional DAXRC are available from your Dayton Audio dealer.

Five LEDs on the keypad face indicate the operation mode of the keypad. The EXT LED indicates that the system is receiving a trigger command from an external device.

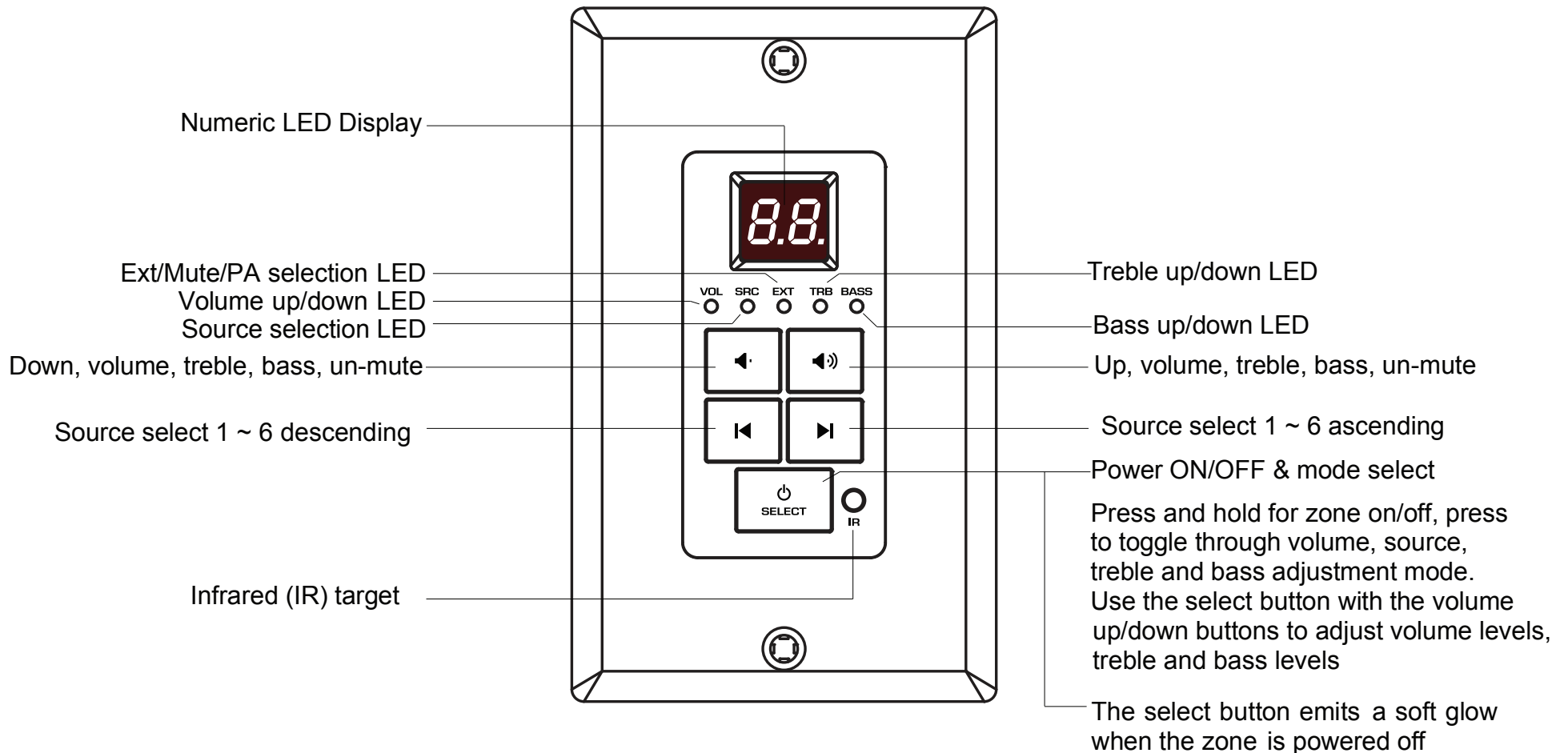

DAX66 INFRARED REMOTE CONTROL FEATURES

The DAXRC infrared remote control provides complete zone control through the IR receiver located on the DAX66 keypad. All keypad functions can be accessed using the DAXRC. In addition to the keypad functions, the DAXRC has a MUTE button to temporarily mute audio in the zone. Once the MUTE function is activated the keypad's LED display will flash, indicating the mute status. Press the MUTE button to continue playing music, or press the keypad volume up or down buttons to un-mute the zone. One DAXRC is included with each system, and additional DAXRC are available from your Dayton Audio dealer.

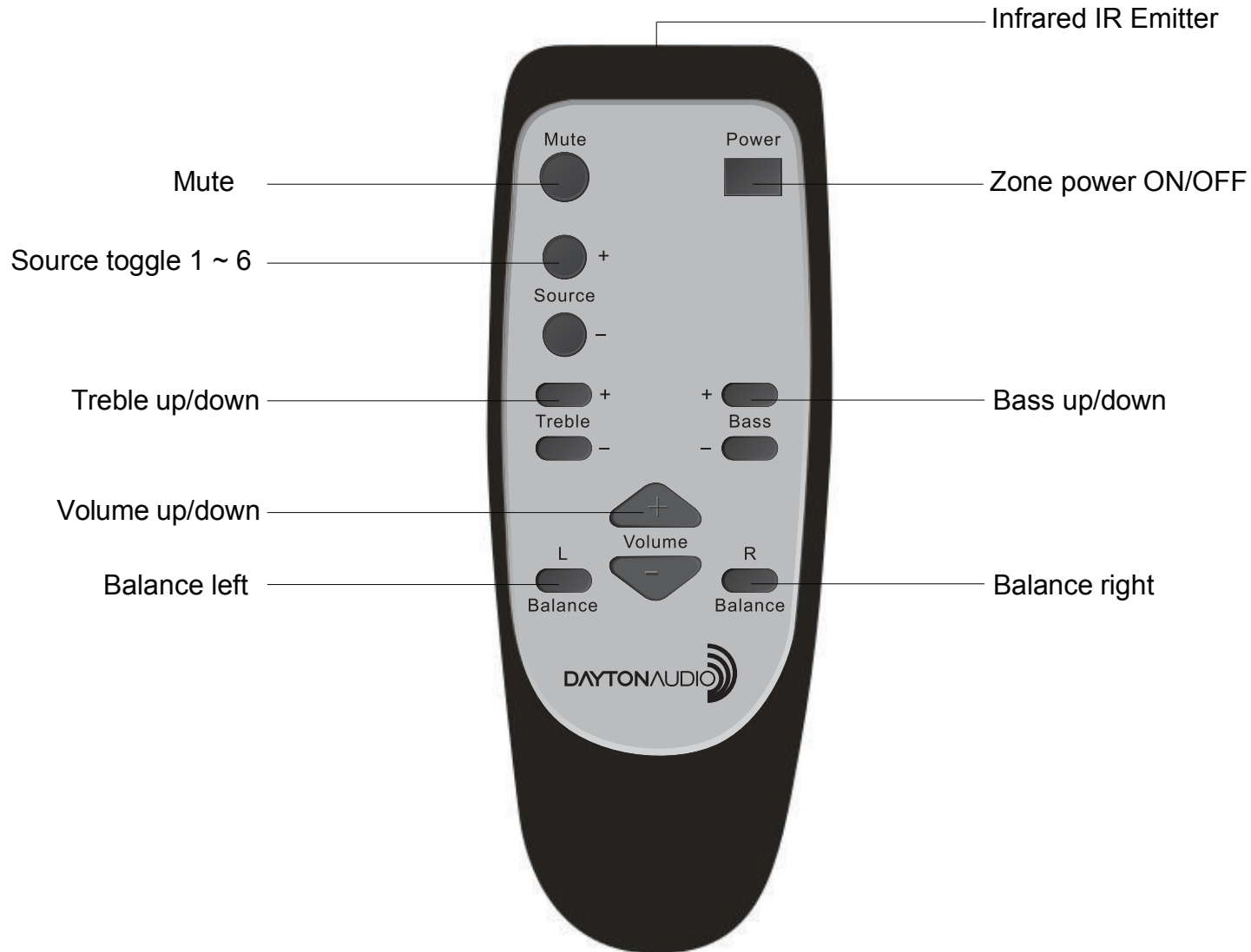

DAX66 INSTALLATION — OVERVIEW

Install the DAX66 in a well-ventilated location; do not block the vents on the sides or top of the chassis, proper ventilation is required for normal operation. Do not expose the unit to excessive dust and do not allow dust to build up on the unit and block the vent holes in the chassis. Do not place the DAX66 above or below heat-generating components such as another audio amplifier. Be sure to leave at least 2 inches of space to the sides of the chassis with open air flow above and below the unit. Due to the weight of the unit, we recommend using four-post racks at minimum.

OVERVIEW:

1. The DAX66 can be mounted in an equipment rack using the included rack mount kit.
2. Always disconnect AC power before making connections to the DAX66.
3. Use good quality 12 or 14 AWG stranded copper speaker wire for all speaker connections.
4. Use good quality cable for connection of the keypads to the master controller/amplifier; we recommend Cat5e to connect keypads.
5. The DAX66 uses a keypad hub; all keypads will connect to the hub. Install the keypad hub close to the master controller/amplifier.
For ease of installation, the keypads and the keypad hub are fitted with quick-disconnect screw terminal blocks.
6. The keypad hub connects easily to the master controller/amplifier using a standard Ethernet patch cable.

NOTE: Set the Address of each keypad using the DIP switches on back of the keypad.

Each keypad must have a distinct address to communicate correctly with the controller/amplifier. Select zone address numbers 1 through 6 by using the chart to the right. A DIP switch in the up position is ON; a DIP switch in the down position is OFF.

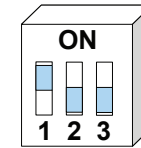

ZONE-1			ZONE-2			ZONE-3		
ON	ON	OFF	ON	OFF	ON	ON	OFF	OFF
1	2	3	1	2	3	1	2	3
ZONE-4			ZONE-5			ZONE-6		
OFF	ON	ON	OFF	ON	OFF	OFF	OFF	ON
1	2	3	1	2	3	1	2	3

NOTE: When attaching a keypad to an electrical box, use a screwdriver to reduce the chance of damage to the keypad.

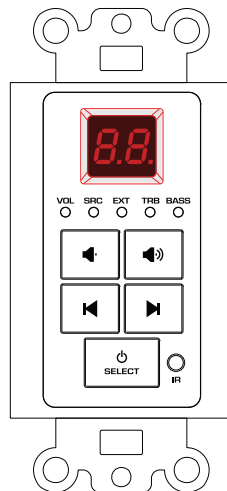
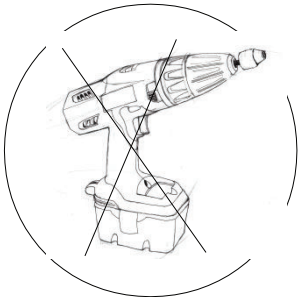

- 1 White and Green
- 2 Green
- 3 White and Orange
- 4 Orange
- 5 White and Blue
- 6 Blue

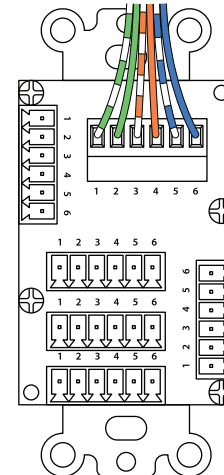
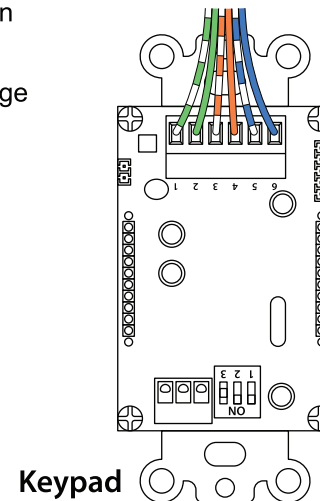
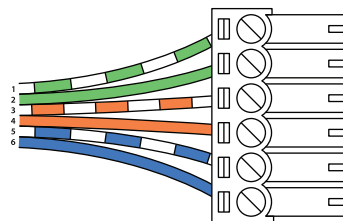

INSTALLATION Keypads

Use high quality Cat5e/6 cable between the controller/amplifier and the keypads. Proper installation techniques will guarantee that the keypads will work properly up to 600 feet from the controller/amplifier. The use of terminal blocks on the keypads and keypad hub ultimately reduces the frustration associated with terminating UTP cable with RJ45 plugs. The PCB is labeled 1 ~ 6 at the location corresponding to the terminal blocks. Attach the conductors in the same order on each end of the cable. See illustrations on the previous page.

- Strip the insulation from the UTP (Cat 5e cable) about three inches. Don't be concerned that too much insulation has been removed since the wire will be hidden in the wall behind the keypad.
- Remove approximately 1/4" of insulation from the conductors and insert into the terminal block. Tighten the screw terminal on the block to hold the wire in place. Do not over tighten the screw to avoid stripping out the terminal.
- Attach the terminal block to the mating connector on the keypad or the keypad hub.

Use standard electrical boxes or low voltage rings to mount the keypads and keypad hub. Mount the keypad hub less than 7 ~ 10 feet from the controller/amplifier. Connect the keypad hub to the master controller/amplifier using a standard Ethernet patch cable.

NOTE: Always follow local building codes and use proper electrical boxes and low voltage rings.

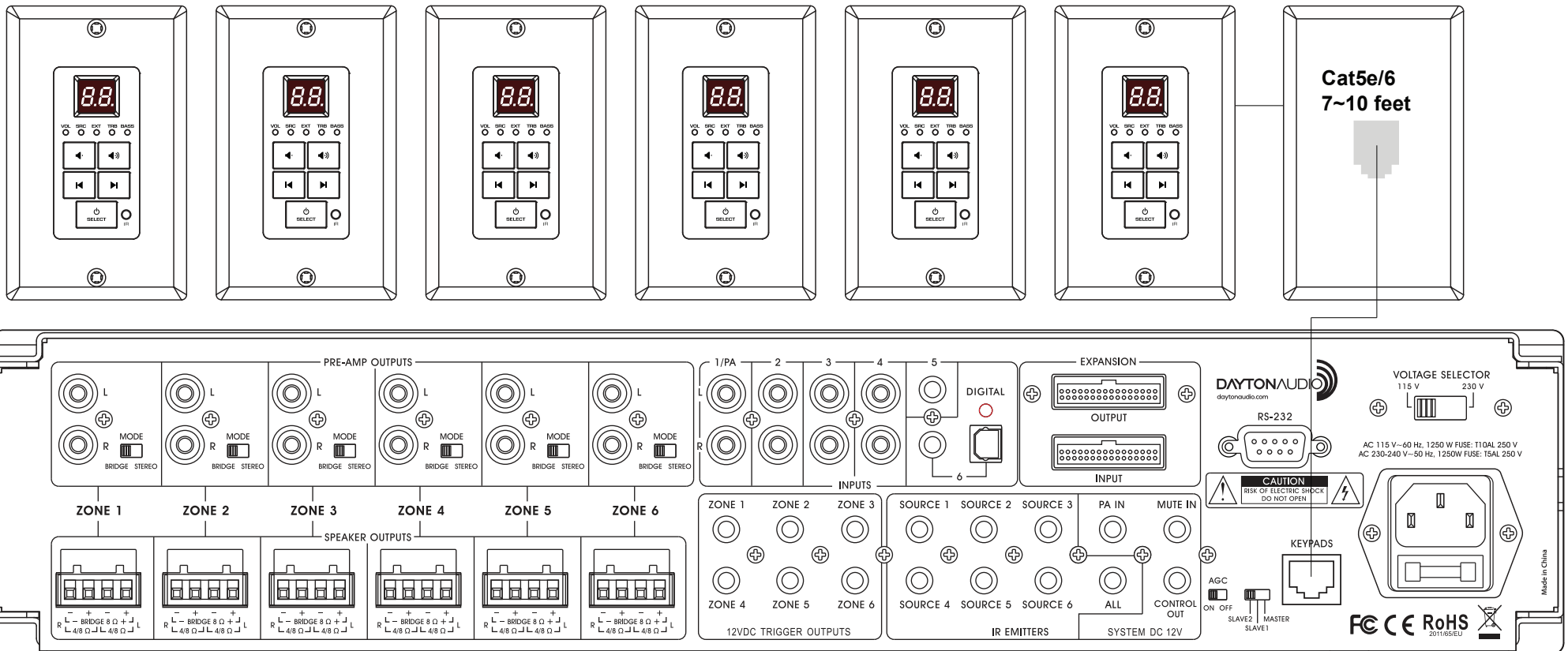

DAX66 INSTALLATION — SPEAKERS

INSTALLATION — Speakers

Use good quality 12-14 AWG stranded copper speaker wire. Most jurisdictions require the use of CL2 rated in-wall speaker wire, refer to your local building code enforcement office for the proper cable type for your installation. If speaker wires must be run parallel to AC wires, keep the speaker wires and AC wires at least 10 inches apart. If you must cross AC wires, always cross at a 90 degree angle.

The DAX66 amplifiers are capable of driving 4 ~ 8 ohm speaker loads in stereo mode, and 8 ohm loads in bridge mode. Never connect more than two 8 ohm speakers wired in parallel to a single amplifier channel in stereo mode. Never connect more than one 8 ohm speaker to a single channel in bridge mode. Never connect the Left & Right channels of the amplifier together or combine the (-) negative channels of the amplifier. Improper speaker installation can damage the amplifiers and void the warranty. If you are unsure how to connect speakers to the DAX66, contact a qualified technician.

Remove the terminal block connector and make sure that all contacts are open by turning each set screw counter clockwise. This helps insure that the speaker wire will not fray when inserted into the terminal.

INSTALLATION: Connecting 8 ohm speakers to the DAX66 in STEREO MODE

Set the amplifier mode switch to STEREO. Remove approximately 5 inches from the cable jacket, strip 1/4" of insulation from the speaker wire, and twist the copper strands. Insert the speaker wires into the connector per the label below the output terminals and tighten the set screws. Repeat for the remaining zones.

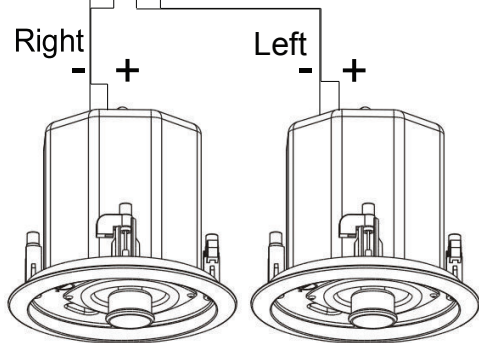
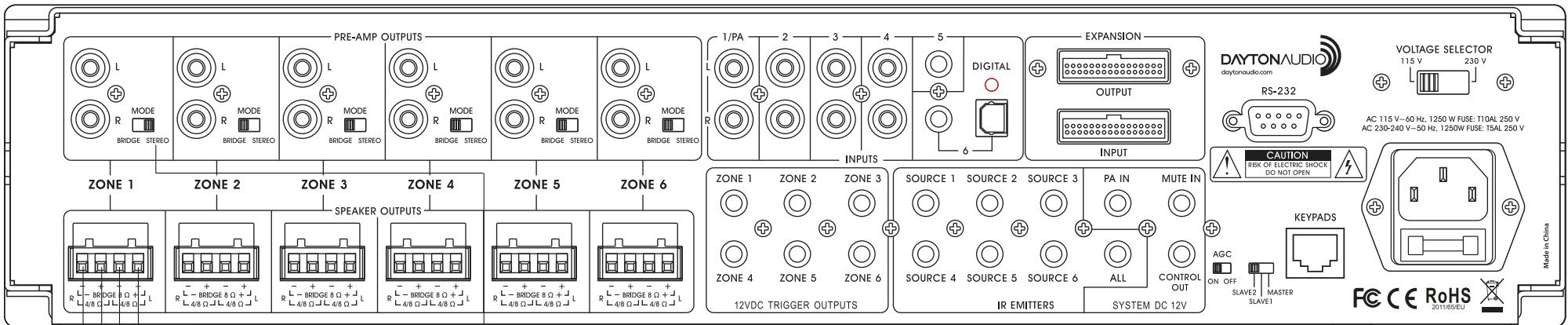

Set the MODE switch
to STEREO

4 ~ 8 ohm
speakers

INSTALLATION: Connecting 8 ohm speakers to the DAX66 in BRIDGE MODE

In BRIDGE mode the amplifier LEFT and RIGHT outputs are combined into one large MONO amplifier, thus doubling the output power to 50 watts with a minimum speaker load of 8 ohms.

Remove approximately 5 inches from the cable jacket, strip 1/4" of insulation from the speaker wire, and twist the copper strands. Insert the speaker wires into the connector per the label below the output terminals and tighten the set screws. Repeat for the remaining zones.

It is permissible to mix STEREO and Bridged MONO outputs on one DAX66.

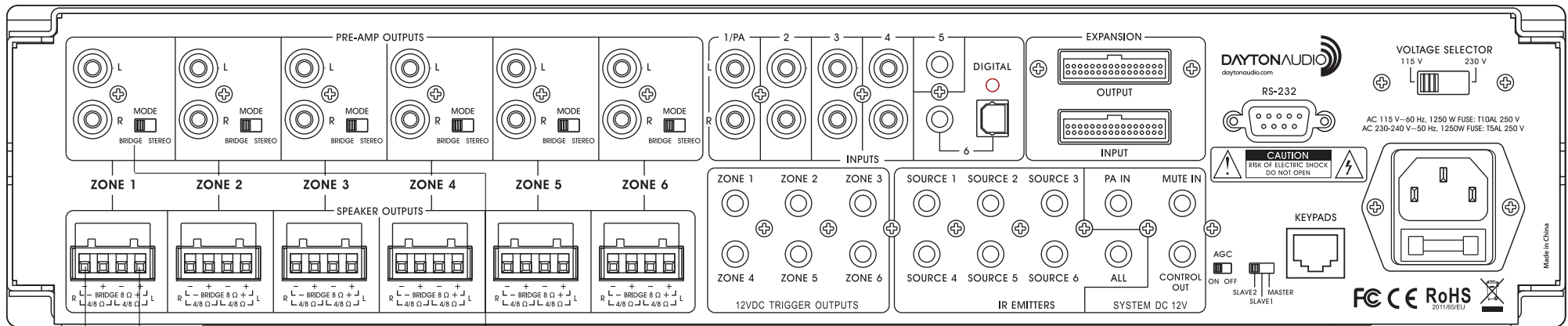

Set the MODE switch to BRIDGE

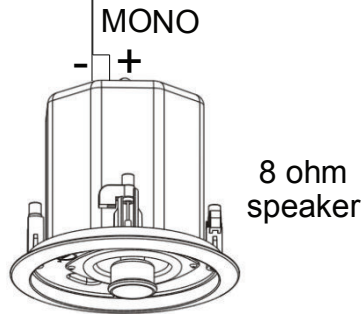

DAX66 INSTALLATION — PRE-AMP OUTPUTS

Using the DAX66 PRE-AMP OUTPUTS

The DAX66 provides six stereo, unbalanced, line level PRE-AMP outputs, which correspond to the six-zone outputs. The PRE-AMP outputs can be used to connect powered subwoofers to a zone or additional amplifiers to expand the available power in a large zone or multiple zones.

The DAX66 can be used as the master controller in large commercial audio systems with constant voltage 25/70V amplifiers connected to the PRE-AMP outputs.

The PRE-AMP output levels are variable and are controlled from the DAX66 keypad, Infrared remote, or RS232 from an automation system. For best performance, the PRE-AMP output cables should be less than 25 feet long and be high-quality, shielded cables.

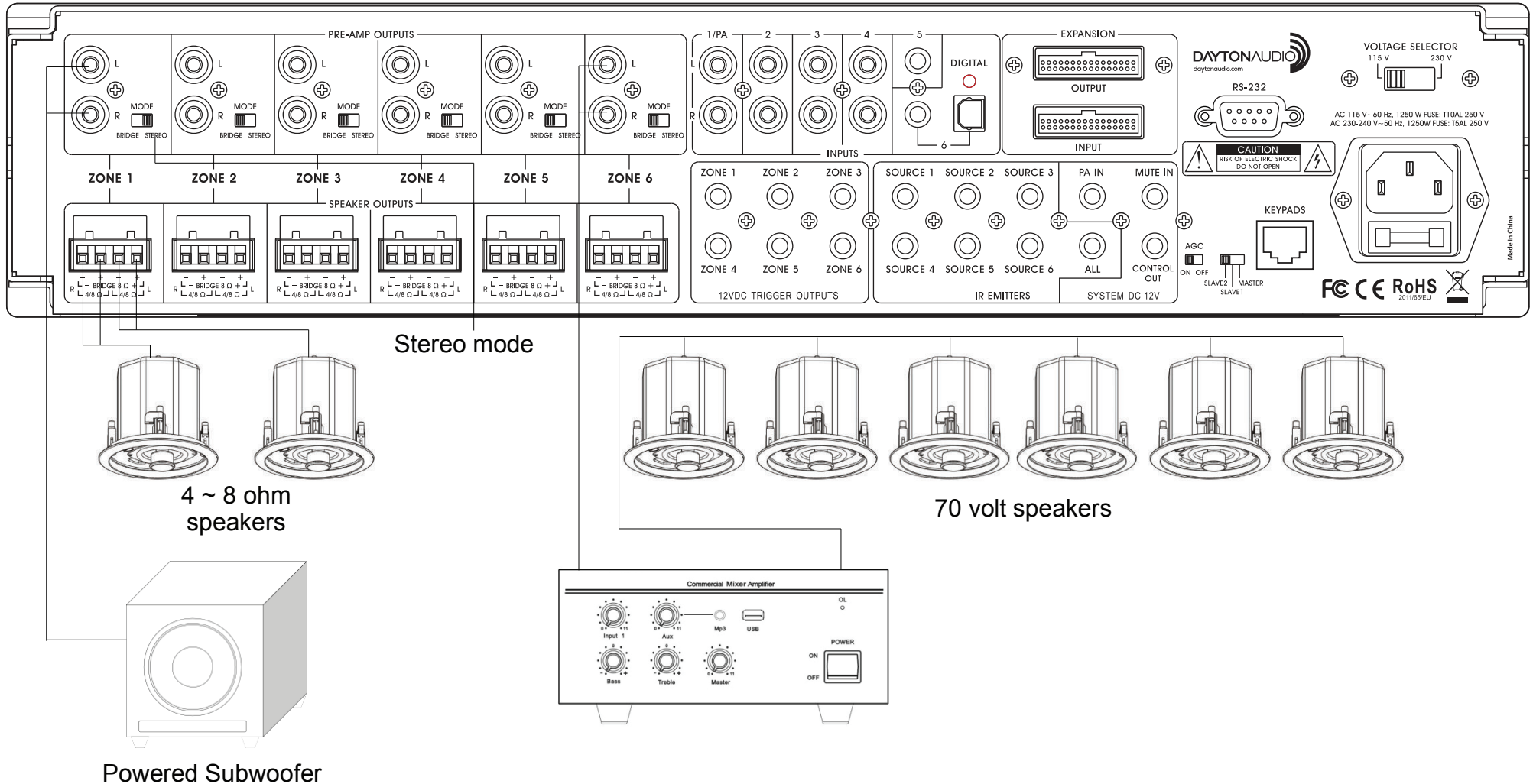

DAX66 INSTALLATION — CONNECTING SOURCES

Connecting Source Components to the DAX66

The DAX66 provides six source inputs that can be accessed by any zone. Inputs 1 ~ 4 are stereo, unbalanced, line level source inputs via RCA style female connectors. Input 5 provides a connection for a personal audio device or PC sound card via the 3.5mm stereo jack. Input 6 provides one S/PDIF input for a CD, DVD, cable, or satellite box via the Toslink jack, as well as a second 3.5mm jack.

The 3.5mm stereo jack on input 6 takes priority over the Toslink connector; do not connect cables to both the Toslink and 3.5mm jack the same time.

Input 1 can be used as a paging or global; all-zones, input. When a source is connected to input 1 and 12Vdc is applied to the PA-IN jack (**tip positive**), source 1 will be broadcast to all zones. If there is no DC voltage is applied to the PA-IN jack, source 1 will operate like normal.

Infrared Emitter Outputs

The DAX66 has an IR repeater system built-in and each source has a corresponding Infrared (IR) emitter output. The IR emitter output is tied to the corresponding source device, or all (global) source control. Program a universal remote to operate all six of the input devices. Point the universal remote at the DAX66 keypad to transmit the IR control codes through the DAX66 to the source devices. With an IR emitter connected to an IR EMITTER output jack and the emitter placed over the source device IR receiver window, the source devices can be controlled from any zone.

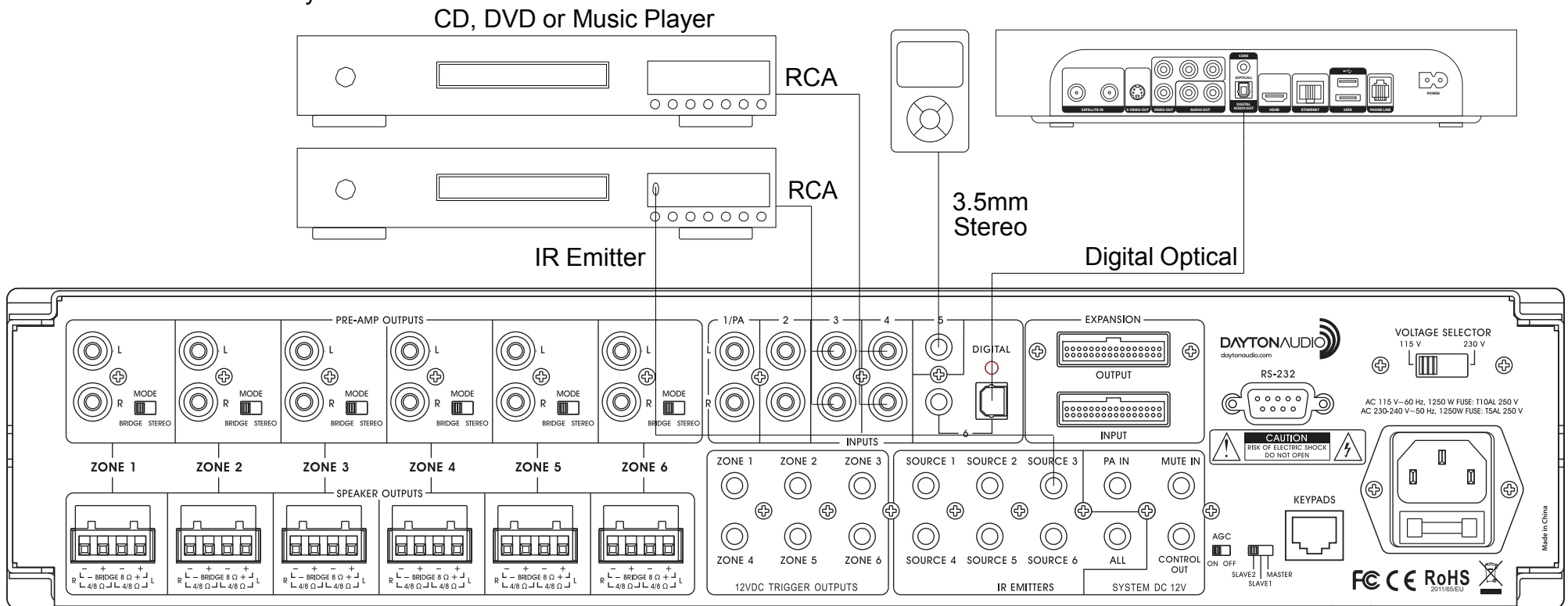

DAX66 INSTALLATION — 12V TRIGGERS

Using the DAX66 12VDC Trigger Inputs and Outputs

The DAX66 provides six 12Vdc trigger outputs which correspond to the six DAX66 zones. When a zone is powered ON by the DAX66 keypad, the corresponding zone sends 12Vdc to the trigger output jack. When the zone is powered OFF, 12Vdc is disconnected from the trigger output. The triggers can be used to automatically switch peripheral equipment ON/OFF. The DAX66 also provides a master control 12Vdc trigger output that sends 12Vdc to the CONTROL OUT jack when any zone is powered ON and disconnects the 12Vdc when all zones are powered off.

DAX66 Trigger outputs:

ZONES 1 ~ 6: Zone ON; 12Vdc applied to the TRIGGER OUTPUT, Zone OFF; 12Vdc removed from the TRIGGER OUTPUT.

CONTROL: Any zone ON; 12Vdc applied to the CONTROL OUT, All zones OFF; 12Vdc removed from the CONTROL OUT

DAX66 Trigger Inputs:

PA- IN: Apply 12Vdc for input #1 override on all six zones.

MUTE – IN: Apply 12Vdc to mute all zones.

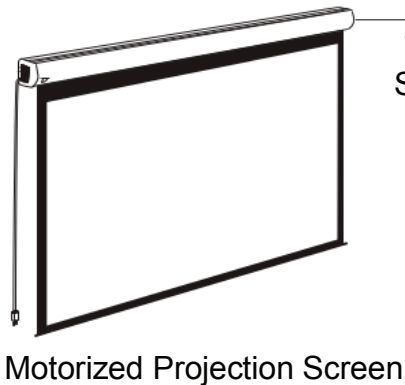
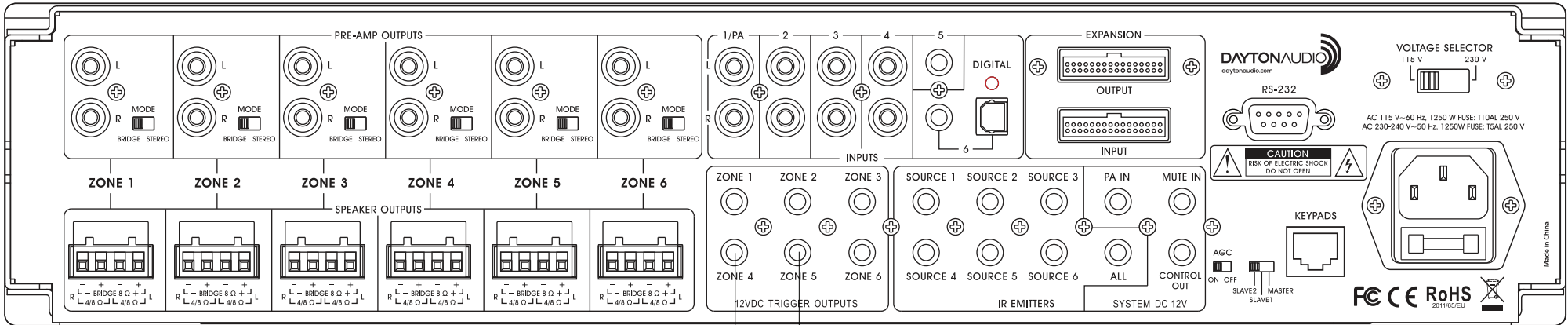

To Projection
Screen 12 Vdc
Trigger In

To External
Amplifier
12VDC Trigger In



WIRING: 3.5mm Mono
Plug: Tip Positive.

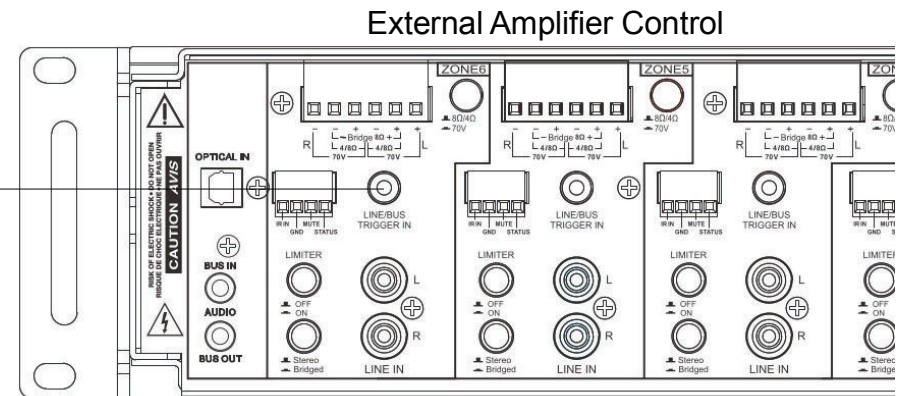

DAX66 INSTALLATION — EXPANSION

Expanding the DAX66 to 18 zones

The DAX66 can be expanded to 12 zones with one additional DAX66 kit and to 18 zones with two additional DAX66 kits. Stack three DAX66, one on top of another. Connect the included 18-pin ribbon cable to the EXPANSION OUTPUT terminal of the bottom unit and the other end of the ribbon cable to the EXPANSION INPUT terminal of the second and then third unit. Set the MASTER/SLAVE-1/SLAVE-2 switch of the bottom unit to MASTER, the center unit to SLAVE-1, and the top unit to SLAVE-2. The following data and control is transmitted between the three units; all source audio, all RS232 control data, and all MCU communication data.

SLAVE 2

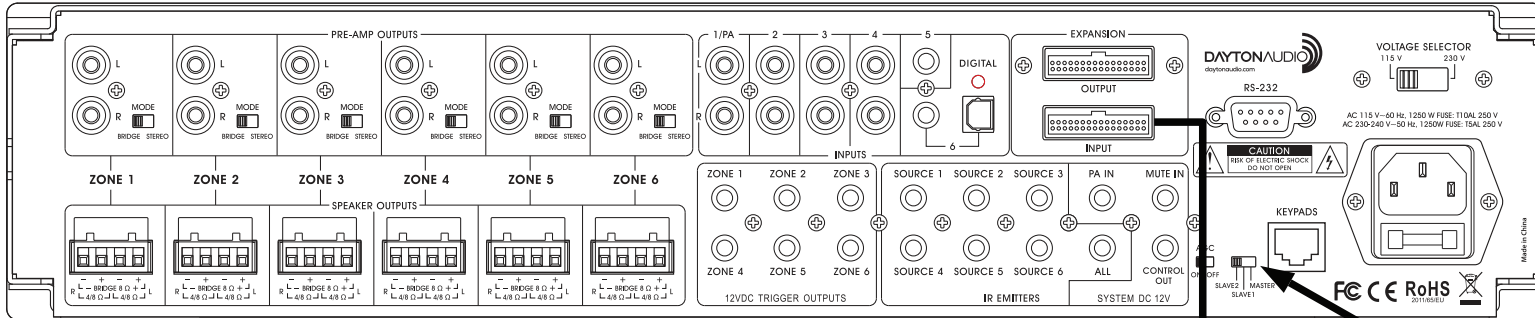

SLAVE 1

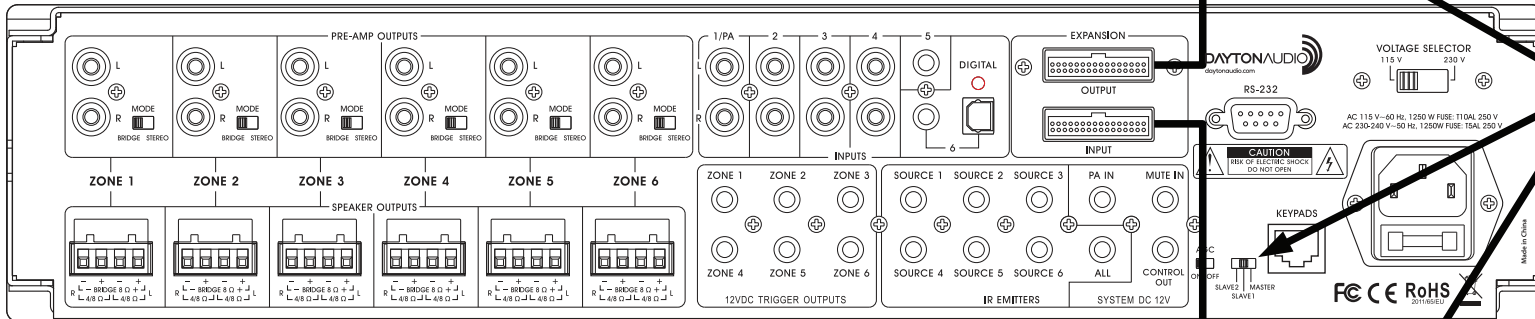

MASTER

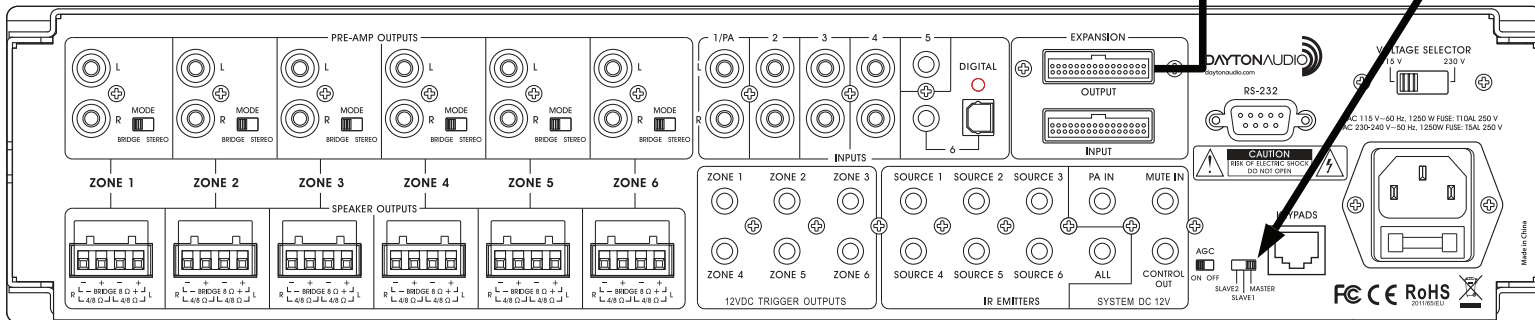

Master
Slave
Select

DAX66 RS-232 Serial Port Control

The DAX66 provides an RS-232 serial port for connection to and control by automation systems. The DB-9 connector on the back of the unit supports bi-directional RS-232 communication for third party automation systems. An automation system can control all keypad and remote control functions for up to 18 zones (3 master controller units), linked together using the included 18 pin expansion cable.

(Baud Rate 9600, 8, N, 1, DB9 Connector Pin out, TX, RX, GND)

DAX66 RS-232 CONTROL

'CR':Carriage Return (0x0D)

No case capitalization/ lowercase

Control order structure <xxPPuu'CR'

Reply control order frame >xxPPuu'CR'

xx: stands for control object code

10 :All Zone of Main unit 1.

20 :All Zone of Main unit 2.

30 :All Zone of Main unit 3.

:Zone1 of Main unit 1.

:Zone2 of Main unit 1.

:Zone3 of Main unit 1.

.....

PP: Stands for control action code.

PR:Power control

PR00:Power off PR01:Power on

MU:Mute control

MU00:Mute off MU01:Mute on

DT:Do Not Disturb control

DT00:DT control off

DT01:DT control on

VO:Volume control

VO(00-38):Volume control

TR:Treble control

TR(00-14):Treble control

BS:Bass control

BS(00-14):Bass control

BL:Balance control

BL(00-20):Balance control

CH:Source Channel control CH(01-

06):Source control

Inquiry command structure (1) ?xx'CR'

xx: stands for control object code

10 : All Zone of Main unit 1.

20 : All Zone of Main unit 2.

30 : All Zone of Main unit 3.

: Zone1 of Main unit 1

: Zone2 of Main unit 1

: Zone3 of Main unit 1

: Zone1 of Main unit 2

: Zone2 of Main unit 2

: Zone3 of Main unit 2

.....

Reply command: >xxaabbccddeeffgghhijj'CR'

aa: PA control status

bb: Power control status ([5]:Backup Zone Power Status

(only on zone)

cc: Mute control status

dd: DT control status

ee: Volume control status

ff: Treble control status

gg: Bass control status

DAX66 RS-232 Serial Port Control continued.
(Baud Rate 9600, 8, N, 1 , DB9 Connector Pin out, Tx, Rx, GND)

hh: Balance control status
ii: Source control status
jj: keypad connecting status
(00:disconnect 01:connected)
Inquiry command structure (2) ?xxPP'CR'
xx: stands for control object code
10 : All Zone of Main unit 1.
20 : All Zone of Main unit 2.
30 : All Zone of Main unit 3.
11 : Zone1 of Main unit 1
12 : Zone2 of Main unit 1
13 : Zone3 of Main unit 1
14 : Zone4 of Main unit 1
15 : Zone5 of Main unit 1
16 : Zone6 of Main unit 1

PP: Stands for control action code.
PA: PA control
PR: Power control
MU: Mute control
DT: DT control
VO: Volume control
TR: Treble control
BS: Bass control
BL: Balance control
CH: Source control
LS: keypad connecting status
Reply command: >xxPPuu'CR'

Key in 1<*****'CR' change Source 1 Name
display;*****needs to be 8 valid ASCII codes.
Key in 2<*****'CR' change Source 2 Name
display
Key in 3<*****'CR' change Source 3 Name
display
Key in 4<*****'CR' change Source 4 Name
display
Key in 5<*****'CR' change Source 5 Name
display
Key in 6<*****'CR' change Source 6 Name
display

Key in M<*****'CR' change the name display on
keypad when turn on.
Key in <9600'CR' change RS232 speed rate to 9600
Key in <19200'CR' change RS232 speed rate to
19200
Key in <38400'CR' change RS232 speed rate to
38400
Key in <57600'CR' change RS232 speed rate to
57600
Key in <115200'CR' change RS232 speed rate to
115200
Key in <230400'CR' change RS232 speed rate to
230400
When unplugging and re-plugging the AC power
cord, the baud speed rate returns to 9600.
ee: Volumecontrol status
ff: Treblecontrol status
gg: Bass control status
hh: Balancecontrol status
ii: Sourcecontrol status
jj: keypad connect status

DAX66 RS-232 Serial Port Control continued

(Baud Rate 9600, 8, N, 1 , DB9 Connector Pin out, Tx, Rx, GND)

(00:disconnect 01:connected)
Inquiry command structure (2) ?xxPP'CR'
xx: stands for control object code
10 : All Zone of Main unit 1.
20 : All Zone of Main unit 2.
30 : All Zone of Main unit 3.
11 : Zone1 of Main unit 1
12 : Zone2 of Main unit 1
13 : Zone3 of Main unit 1
14 : Zone4 of Main unit 1
15 : Zone5 of Main unit 1
16 : Zone6 of Main unit 1

PP: Stands for control action code.
PA: PA control
PR: Power control
MU: Mute control
DT: DT control
VO: Volume control
TR: Treble control
BS: Bass control
BL: Balance control
CH: Source control
LS: keypad connecting status

Reply command: >xxPPuu'CR'

Reply command: >xxPPuu'CR'
;*****needs to be 8 ASCII codes.
Key in 1<*****'CR' change Source 1 Name display
Key in 2<*****'CR' change Source 2 Name display
Key in 3<*****'CR' change Source 3 Name display
Key in 4<*****'CR' change Source 4 Name display
Key in 5<*****'CR' change Source 5 Name display
Key in 6<*****'CR' change Source 6 Name display

Key in M<*****'CR' change the name in the display
On the keypad when the keypad is turned on.
Key in <9600'CR' change RS232 speed rate to 9600
Key in <19200'CR' change RS232 speed rate to 19200
Key in <38400'CR' change RS232 speed rate to 38400
Key in <57600'CR' change RS232 speed rate to 57600
Key in <115200'CR' change RS232 speed rate to 115200
Key in <230400'CR' change RS232 speed rate to 230400
When unplugging and re-plugging the AC power cord, the
Baud speed rate will return to 9600.

DAX66 SPECIFICATIONS & WARRANTY

RMS Power @ 8 ohms	25 watts x 12
RMS Power @ 4 ohms	50 watts x 12
RMS Power @ 8 ohms Bridge Mode	100 watts x 6
S/N Ratio	>85dB A Weighted
THD	<0.1%
Frequency Response	20 ~ 20,000 Hz
Input Impedance	>47K ohms
Input Sensitivity	250mv
Amplifier Protection	Overload, Short Circuit & Thermal
Trigger Systems ON Voltage	DC + 12V
Trigger External Mute Voltage	DC + 12V
Infrared Frequency Band	38kHz
Input Connectors	3.5mm stereo, RCA, Toslink
Output Connectors	Terminal Block, RCA
Power Supply (switchable)	AC115V/60Hz, 230V/50Hz
Dimensions	16.9" (W) x 3.5" (H) x 16.4" (D)
Weight	24.25 lbs.
Warranty	5 Years

Specifications are subject to change from time to time without notice.

Contact Information:
Dayton Audio
705 Pleasant Valley Drive
Springboro, OH 45406
PH: 937-743-8248
E-Mail: info@daytonaudio.com
Web: www.daytonaudio.com

Warranty

This Dayton Audio® product is warranted free from defects in material and workmanship for a period of five years from date of purchase. Product registration is not required; however keep the original invoice as proof of purchase. Warranty does not apply to misuse, abuse, neglect, accident, improper use, etc. To process a return or have your product replaced under warranty, please contact your Dayton Audio reseller to obtain an RA #. Pack merchandise carefully to avoid further damage and complete the Return Form on the bottom of the invoice. Record customer and RA numbers on the outside of the box. Ship merchandise back to your Dayton Audio reseller prepaid.

©2014 Dayton Audio®, all rights reserved.
All trademarks are the property of their respective owners. Specifications are subject to change without notice. Dayton Audio cannot be held liable for typographical errors or omissions.