VCD[®]400

High Grade Audio Power Amplifier

Stereo kit

Assembly Instructions



UcD400 stereo kit, a brief introduction

Thank you for purchasing the Hypex UcD400 stereo kit, powered by our UcD® technology.

The UcD® amplifier and the Switch Mode Power Supply used in this kit are:

- **UcD400HG with HxR (2x)**
- **SMPS400A400 (1x)**

This stereo kit can be a 2 channel poweramp for your passive loudspeakers. We offer two kinds of stereo kits:

- **UcD180 stereo kit**, 2x180W
- **UcD400 stereo kit**, 2x200W

Please read the safety instructions on the next page before assembling and installing and/or operating the UcD® stereo kit.

Please note the different models. This assembly instruction describes how to assemble one of these models. Both models only offers balanced inputs, if your source only offers unbalanced output's you can use one of our interconnects to connect them properly.

This assembly instruction covers the general assembly instructions for this specific model. For detailed technical information about the used modules please refer to the datasheet on our website.

Included in the kit

- Complete Hypex DIY case
- 2x UcD® amplifier
- Switch Mode Power Supply
- Complete internal cable harness
- Mounting plate
- All required connectors
- All required mounting materials
- This assembly instruction

Not included in the kit

- Power cable
- Loudspeaker cables
- Interconnects
- Tools as described at page 4

Table of Contents

Chapter	Page
Introduction, Table of contents	2
Safety precautions	3
Tools	4
Parts	4
Assembly	7
System Information	25
Advanced System Information	25
Troubleshooting	26
FAQ	26
Support	26
Warranty	27
Disclaimer	27
Revisions	27
Notes	27

Safety precautions

This unit operates at mains voltage and carries hazardous voltages at accessible parts. These parts may never be exposed to inadvertent touch. Observe extreme care during installation and never touch module of the unit while it is connected to the mains. Disconnect the unit from the mains and allow all capacitors to discharge for 10 minutes before handling it.

Damage due to inappropriate handling is not covered by warranty. This product has no user-serviceable parts.

Warning: To reduce the risk of fire or electric shock, do not expose this device to rain or moisture.

Précautions de sécurité

Ce unité est sous tension secteur et certaines de ses pièces accessibles sont sous une tension dangereuse. Ces pièces doivent dans tous les cas être protégées contre contacts accidentels. Lors de l'installation, une prudence extrême s'impose. Ne jamais toucher les pièces du module quand celui-ci est relié au secteur. Isoler l'appareil du secteur et attendre 10 minutes pour laisser à tous les condensateurs le temps de se décharger avant de le manipuler.

Les dommages causés par un usage non approprié sont exclus de la garantie.

Ce produit ne contient aucune pièce devant être entretenue par l'utilisateur.

Avertissement: Pour réduire les risques de choc électrique, ne pas exposer cet appareil à la pluie ou l'humidité.



Attention: Observe precautions for handling electrostatic sensitive devices. This module uses semiconductors that can be damaged by electrostatic discharge (ESD).



The lightning flash with arrowhead symbol within an equilateral triangle is intended to alert the user to the presence of uninsulated "dangerous voltage" within the product's enclosure, that may be of significant magnitude to constitute a risk of electric shock to persons.



The exclamation point within an equilateral triangle is intended to alert the user of the presence of important operating and maintaining (servicing) instructions in the literature accompanying the appliance.



Use a grounded electrical outlet for this appliance.



Utilice un tomacorriente con conexión a tierra para este aparato.



使用此设备的接地电源插座



Utilisez une prise électrique mise à la terre pour cet appareil.



Verwenden Sie für dieses Gerät eine geerdete



Gebruik voor dit apparaat een geaard stopcontact.

1. Read these instructions.
2. Keep these instructions.
3. Heed all warnings.
4. Follow all instructions.
5. Do not use this apparatus near water.
6. Clean only with a dry cloth.
7. Natural convection should not be impeded by covering the module (apart from the end applications housing). Do not block any ventilation openings. Install in accordance with the manufacturer's instructions.
8. Do not install near any heat sources such as radiators, heat registers, stoves, or other apparatus (including amplifiers) that produce heat.
9. Do not defeat the safety purpose of the protective earth / grounding mains inlet. Protective earth is provided for your safety.
10. Protect the power cord from being walked on or pinched particularly at plugs, convenience receptacles, and the point where they exit from the apparatus.
11. Only use attachments/accessories specified by the manufacturer.
12. Unplug this apparatus during lightning storms or when unused for long periods of time.
13. Refer all servicing to qualified service personnel. Servicing is required when the apparatus has been damaged in any way, such as power-supply cord or plug is damaged, liquid has been spilled or objects have fallen into the apparatus, the apparatus has been exposed to rain or moisture, does not operate normally, or has been dropped.
14. This apparatus shall not be exposed to dripping or splashing, and no object filled with liquids, such as vases or beer glasses, shall be placed on the apparatus.
15. Do not overload wall outlets and extension cords as this can result in a risk of fire or electric shock.
16. This apparatus has been designed with Class-I construction and must be connected to a mains socket outlet with a protective earthing connection.
17. This apparatus has been equipped with a rocker-style AC mains power switch. This switch is located on the rear panel and should remain readily accessible to the user.
18. The MAINS plug or an appliance coupler is used as the disconnect device, so the disconnect device shall remain readily operable.
19. Do not run any cables across the top or the bottom of the module. Apply fixtures to cables to ensure that this is not compromised.
20. Before using this product, ensure all cables are correctly connected and the power cables are not damaged. If you detect any damage, do not use the product.
21. Changes or modifications not expressly approved by Hypex Electronics will void compliance and therefore the user's authority to operate the equipment.
22. Service or modifications by any person or persons other than by Hypex Electronics authorized personnel voids the warranty.



Correct disposal of this product: This symbol indicates that this product should not be disposed of with your household waste, according to the WEEE directive (2012/19/EU) and your national law. This product should be handed over to an authorized collection site for recycling waste electrical and electronic equipment (EEE). Improper handling of this type of waste could have a possible negative impact on the environment and human health due to potentially hazardous substances that are generally associated with EEE. At the same time, your cooperation in the correct disposal of this product will contribute to the effective usage of natural resources. For more information about where you can drop off your waste equipment for recycling, please contact your local city office, waste authority, or your household waste disposal service.

Tools (not included)

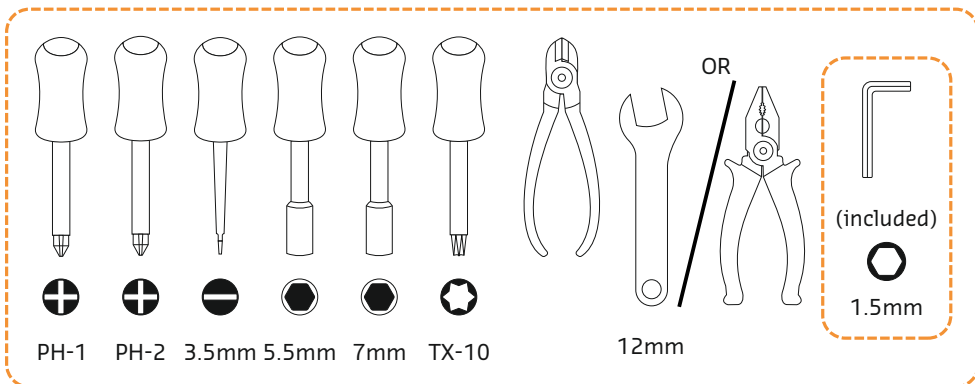

Parts

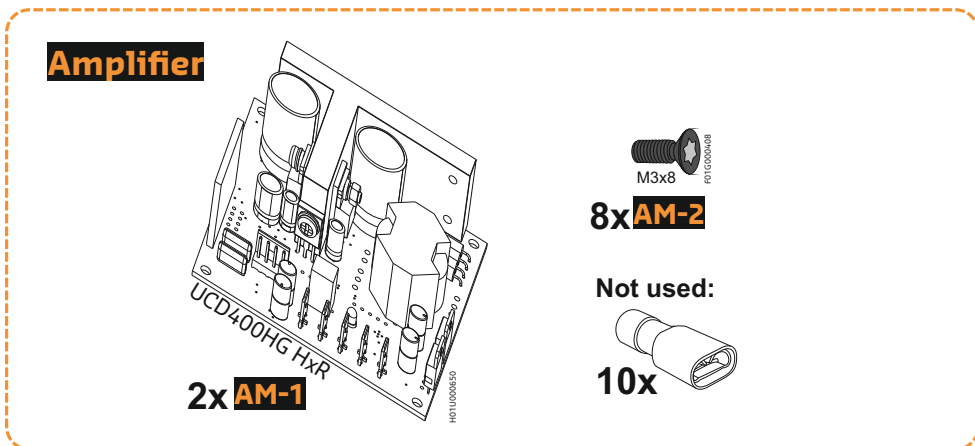
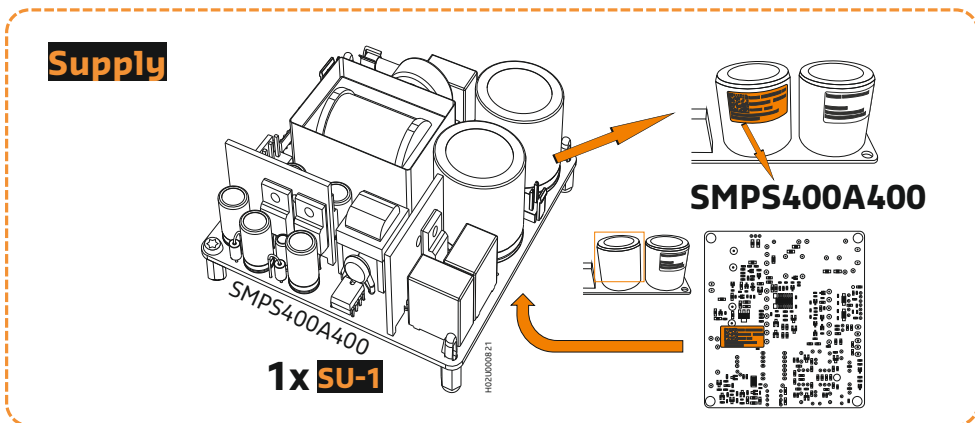

Connection kit

1x **CK-1**

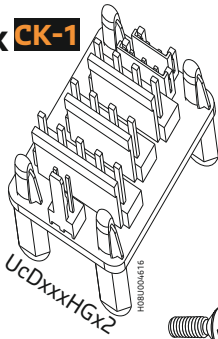

4x **CK-2**

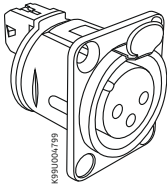

2x **CK-3**



Z1A18.1

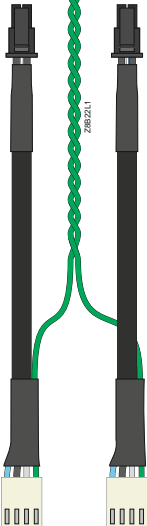

1x **CK-9**

1x **CK-10**



Z1A18.2

1x **CK-11**



Z1A14.1

2x **CK-12**

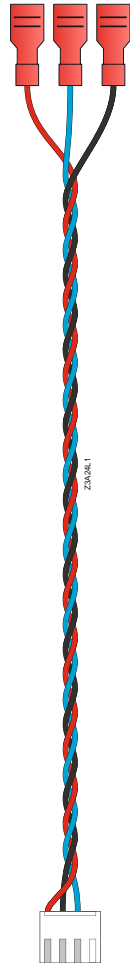

Z1A28.1

1x **CK-13**

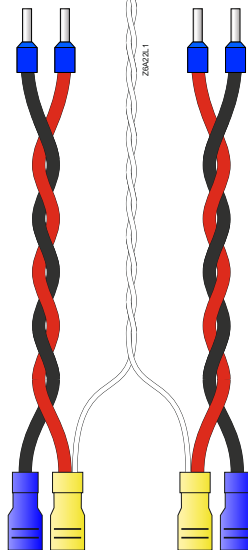

Z1A28.1

1x **CK-14**



Z1A38.7

1x **CK-4**



Z1A18.1

1x **CK-5**



Z1A18.5

1x **CK-6**



M1810000375

1x **CK-7**



Z1A18.4

1x **CK-8**

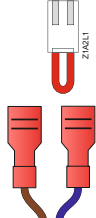

Z1A28.1

H0800047198

Case

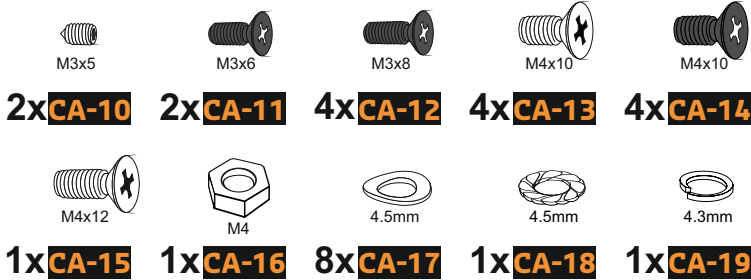
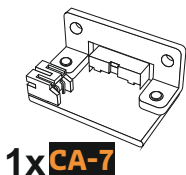
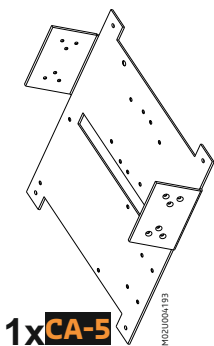
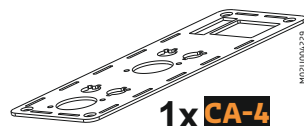
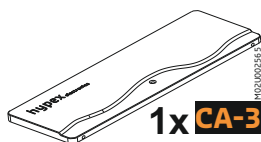
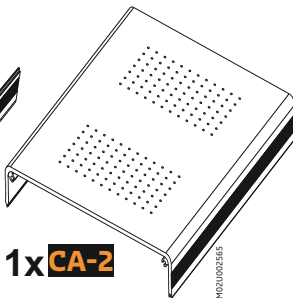
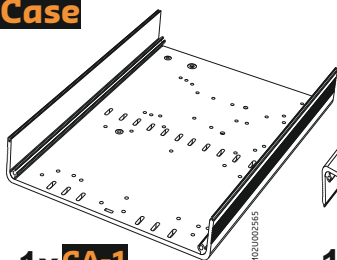

Not used:

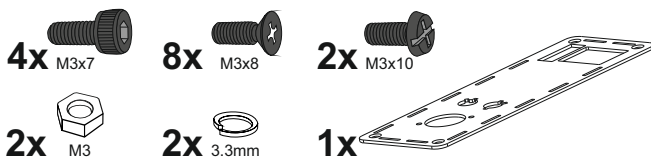

Accessories

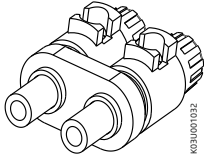

2x **AC-1**

K33U001032

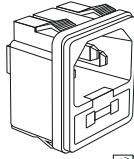

1x **AC-2**

K33U001035



E09U000817



1x **AC-3**

E14U001062



4x **AC-4**

F06G000050



4x **AC-5**

F01G000198



4x **AC-6**

F01G000484

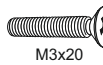

4x **AC-7**

F01G000197



12x **AC-8**

F03G000023



16x **AC-9**

F06G000021



4x **AC-10**

M71U000195



1x **AC-11**

F01G000024



1x **AC-12**

F03G000027



1x **AC-13**

F06G000025



1x **AC-14**

F06G001744

Assembly

Backpanel

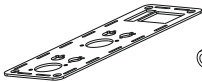

CA-4

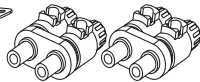

AC-1

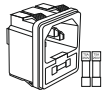

AC-2

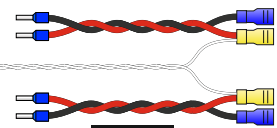

CK-13



AC-3



AC-5



AC-8



AC-9

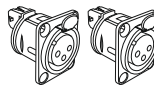

CK-3

1

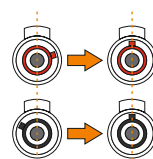
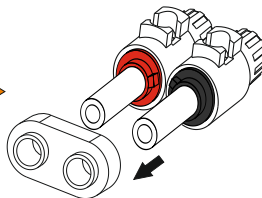
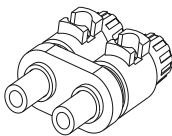

2x

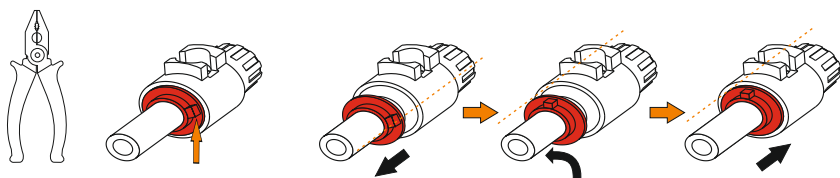

2

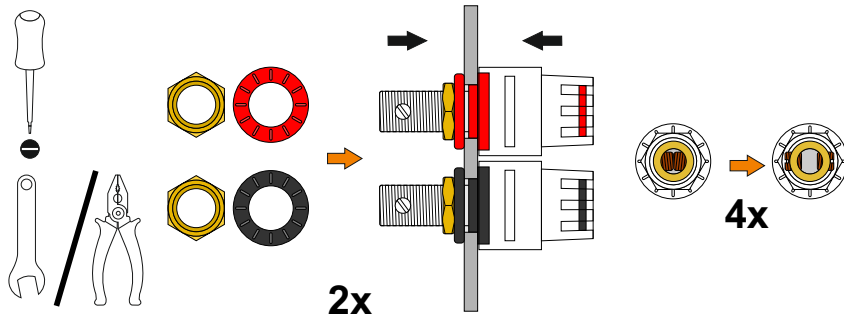
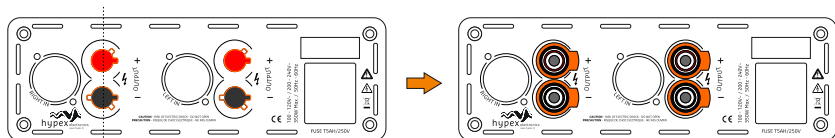

3

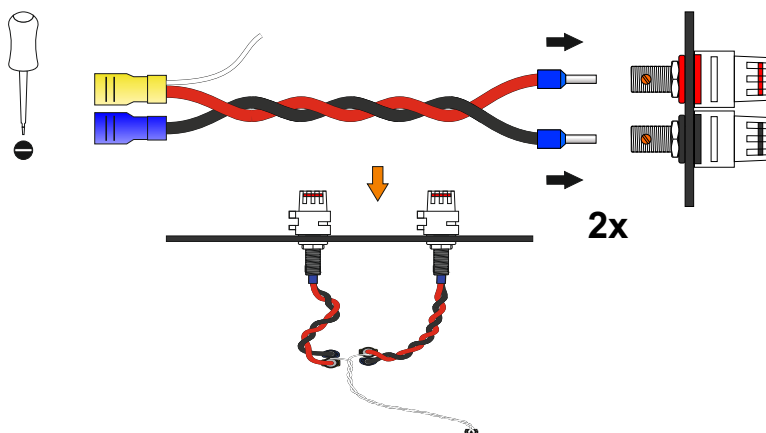

4

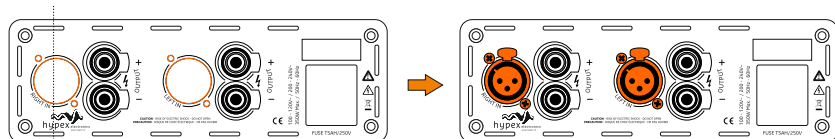

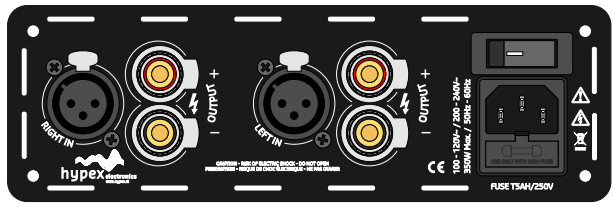
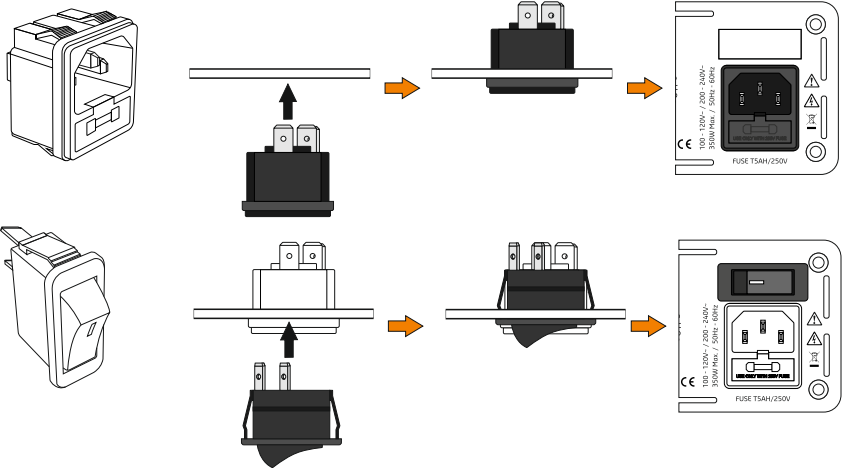
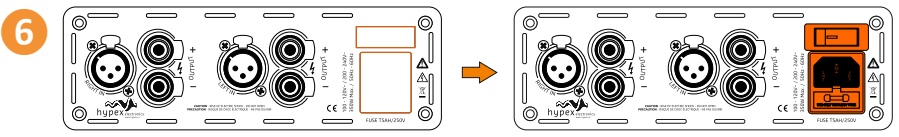
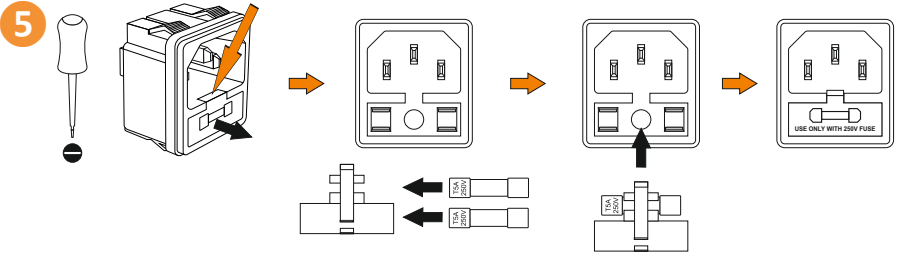
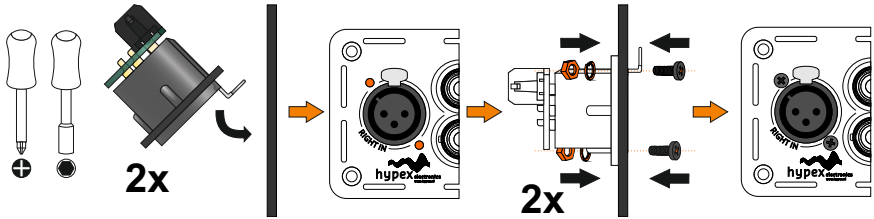

Ground & UcDxxxHGx2

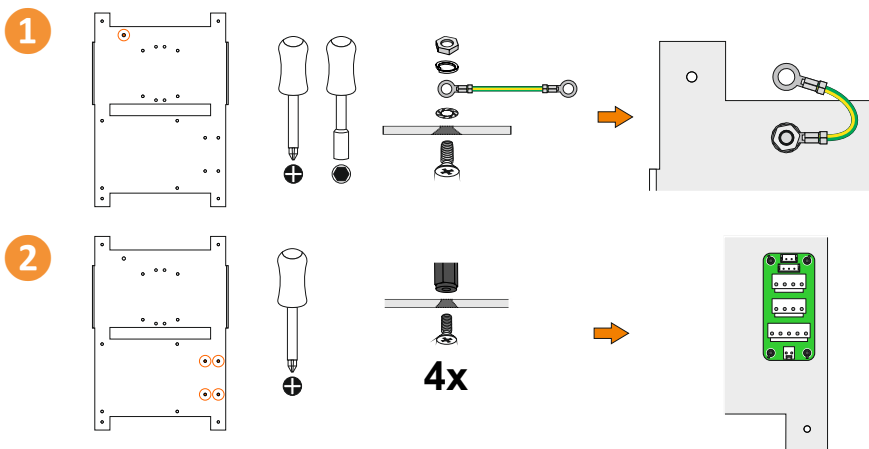
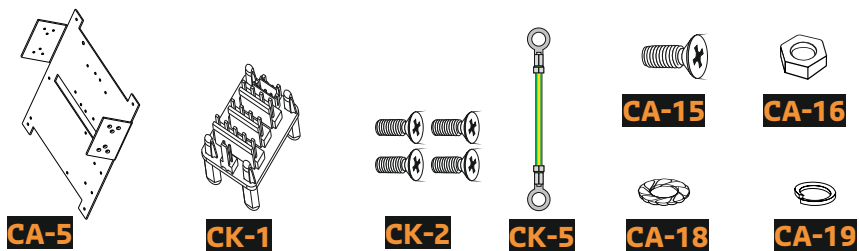

Amplifiers

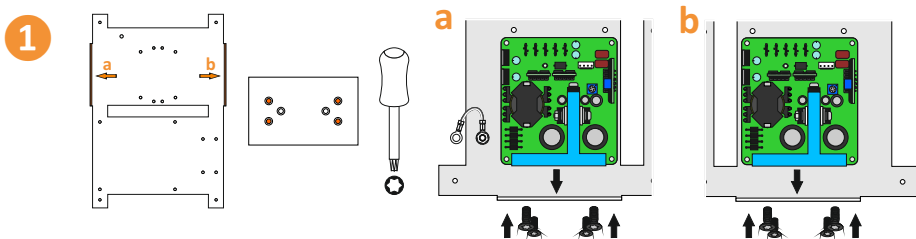

2

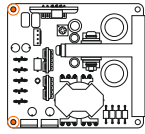
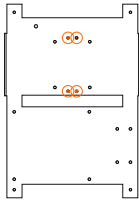

2x

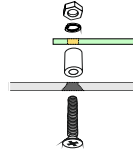
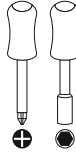

4x

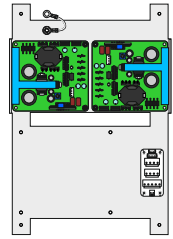

Supply

1

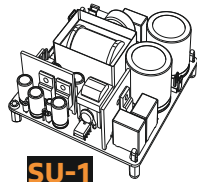
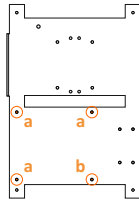

SU-1

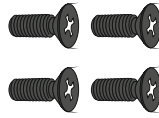

CA-12

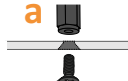

3x

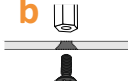

1x

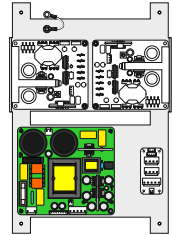

Case

1

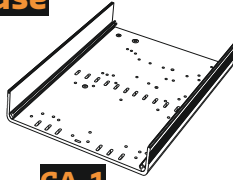

CA-1

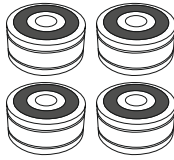

CA-8

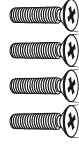

AC-6



AC-8



AC-9

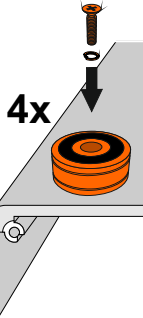

4x

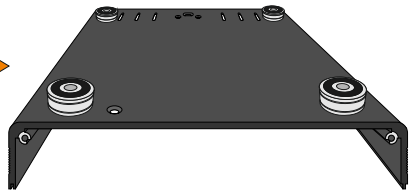

2

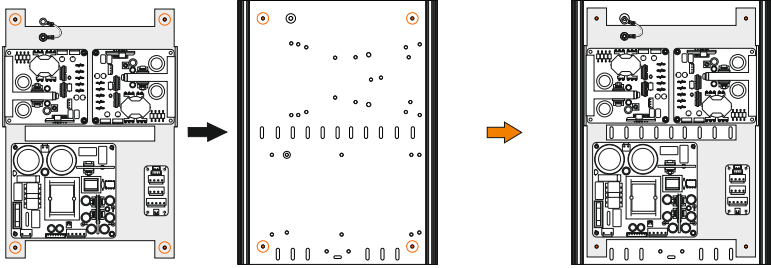

3

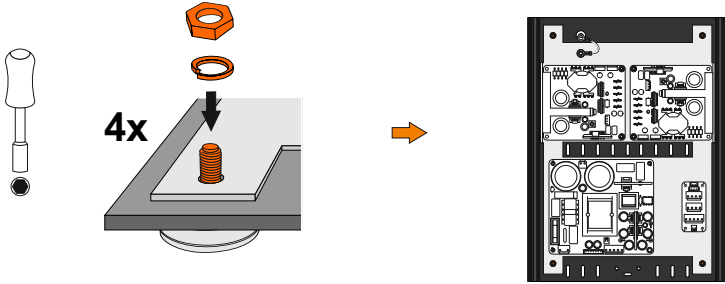

Light & Ground

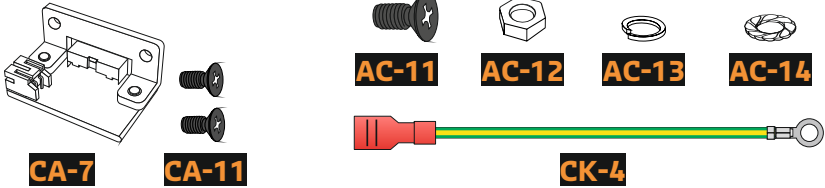

1

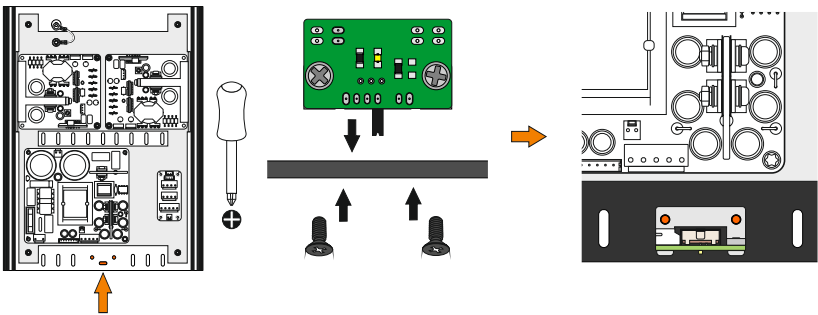

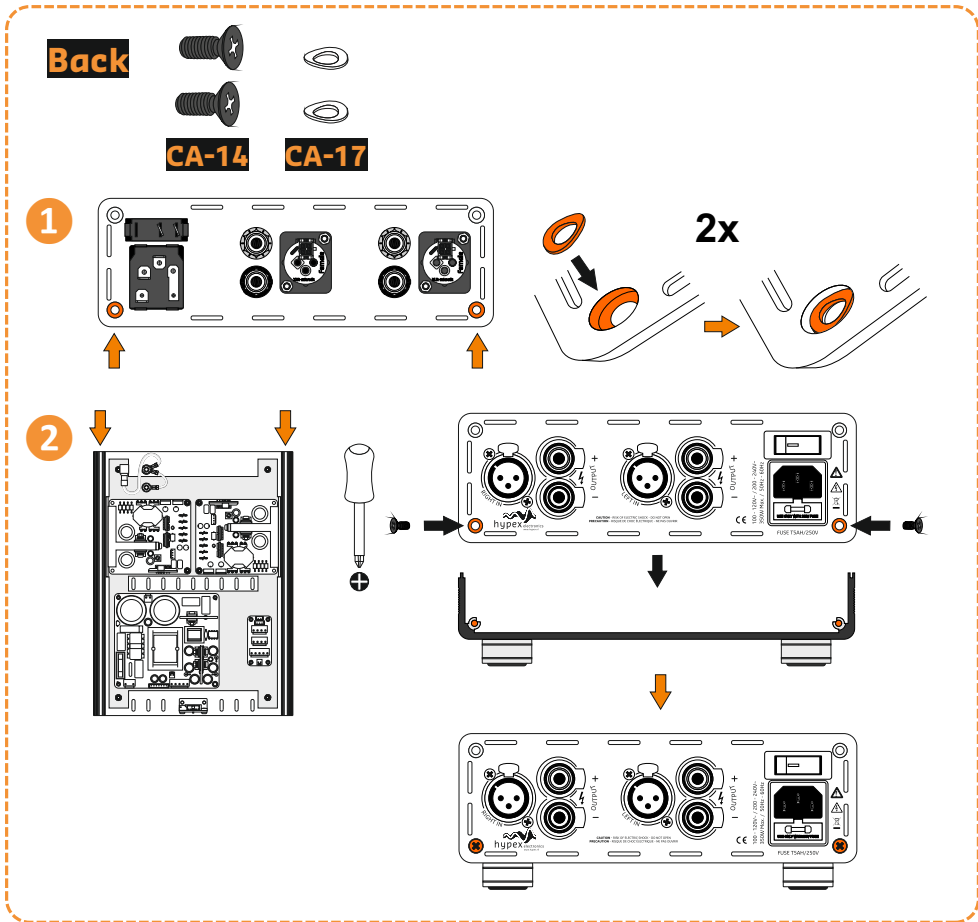
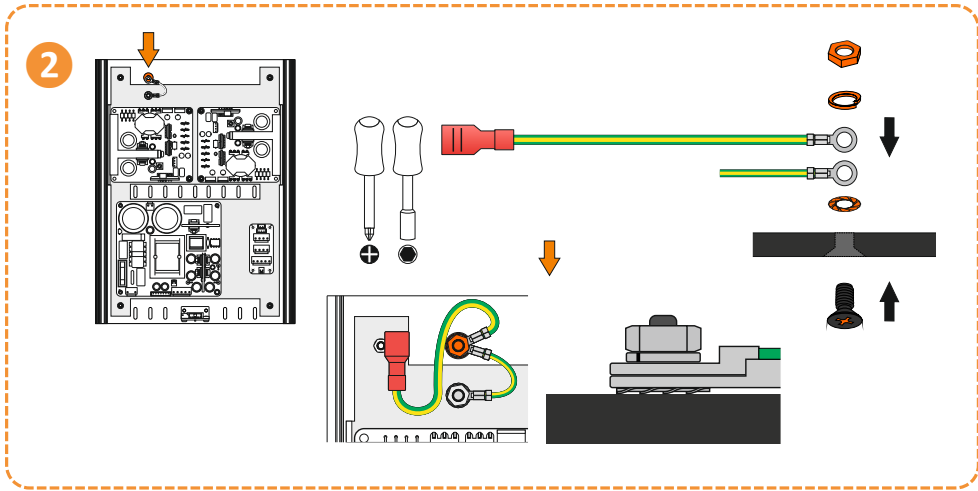

Connections: Audio Output & DC-Error

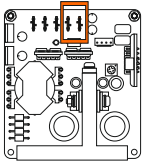

AM-1

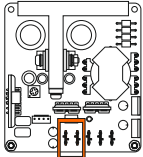

AM-1

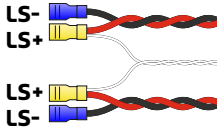

CK-14

DC-
ERROR



CK-1

1

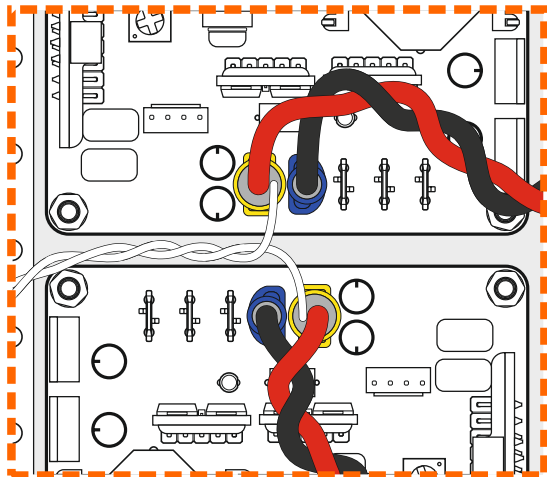
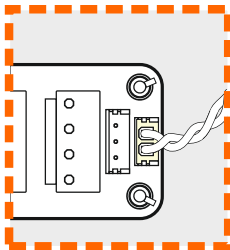
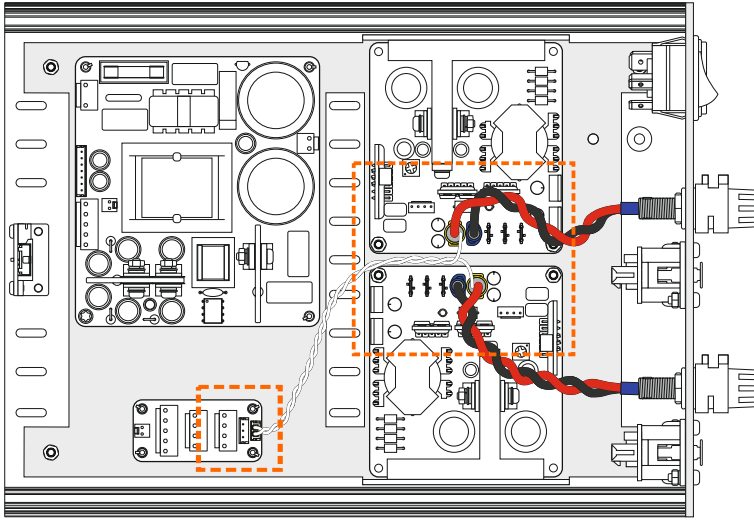

Ground



AC-2

CK-4

1

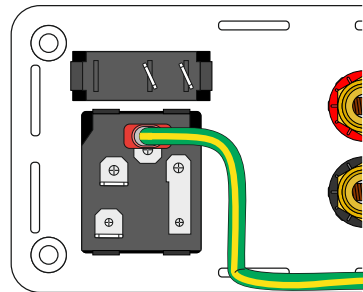
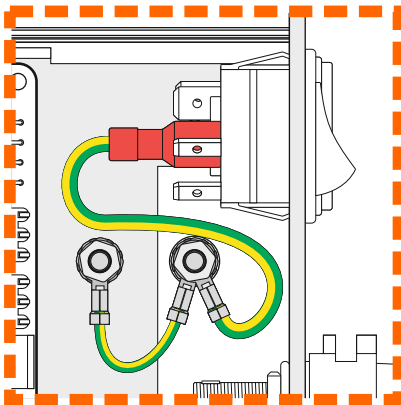
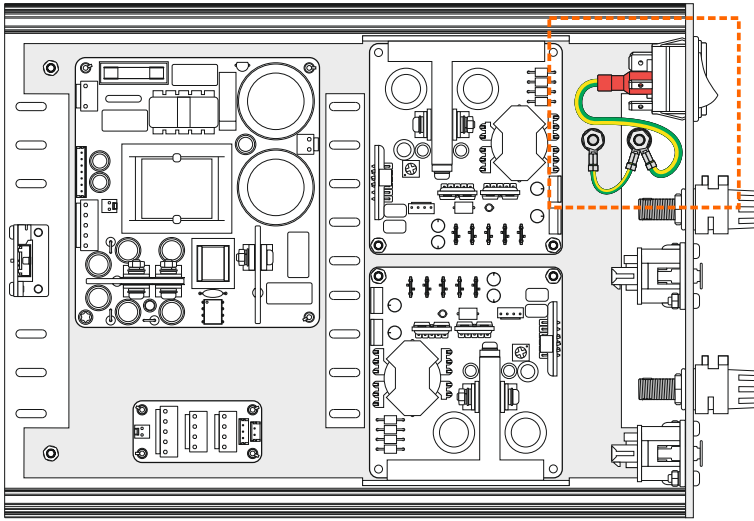

AC Line & Switch

1

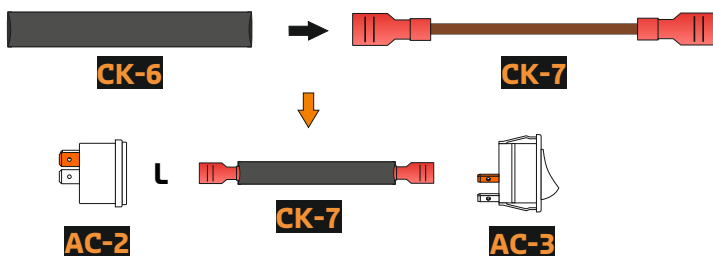

2

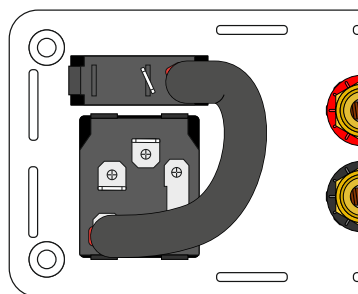
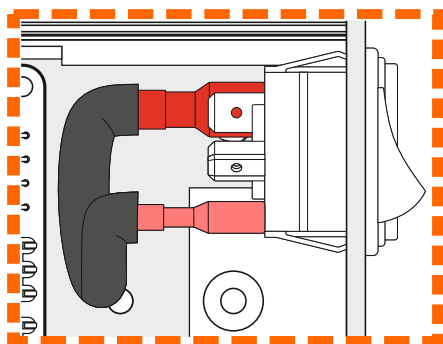
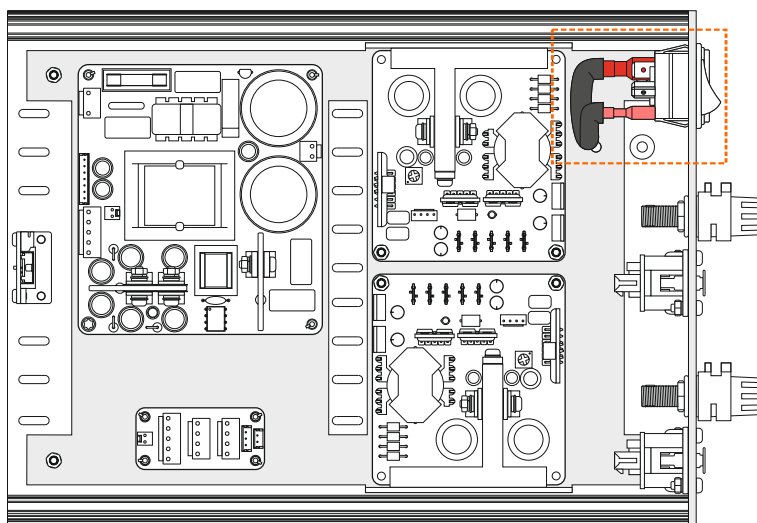

AC Supply

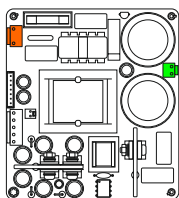

SU-1

CK-8

115Vac Mains 230Vac Mains

A diagram showing two types of connectors for the CK-8 power cord. The left one is a standard 2-prong connector, and the right one is a 3-prong connector with a ground pin, which is crossed out with a large red 'X' to indicate it is incorrect.

J2

CK-14

N

AC-2

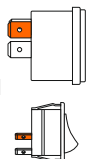

AC-3

1

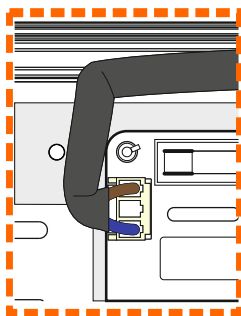
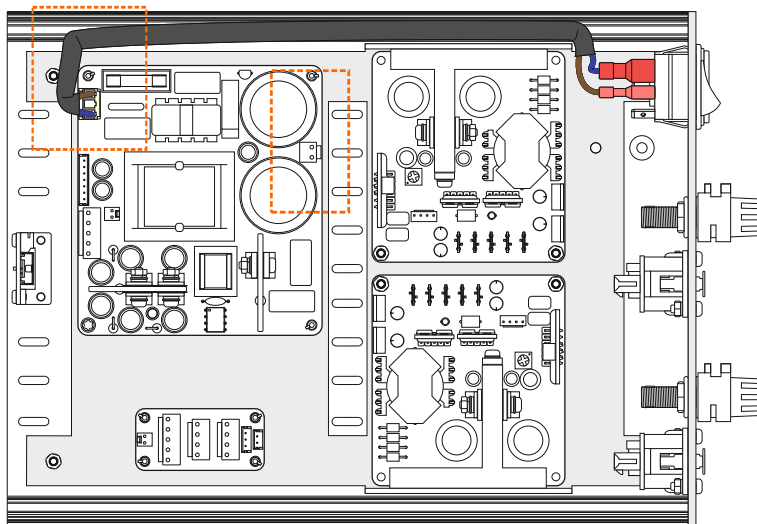

115Vac Mains 230Vac Mains

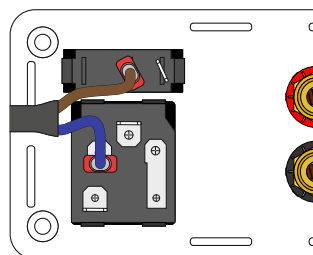
A diagram showing two options for the AC mains connector on the chassis. The left option is for 115Vac Mains and the right option is for 230Vac Mains. The entire diagram is enclosed in a green border.

Light, DC-Error, DC Amp-L

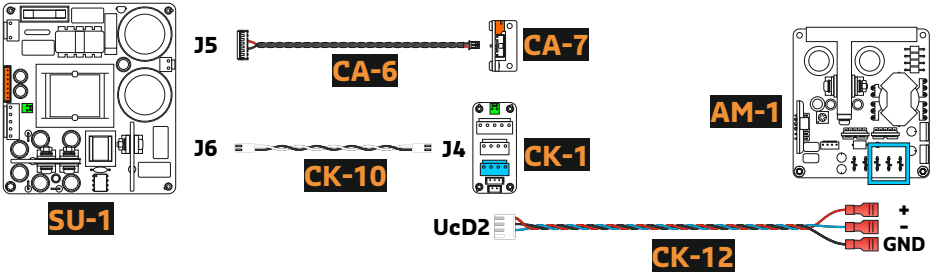

1

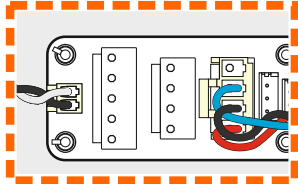
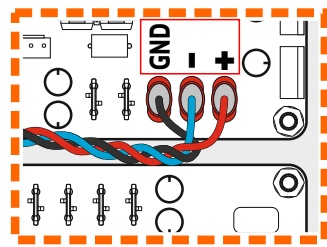
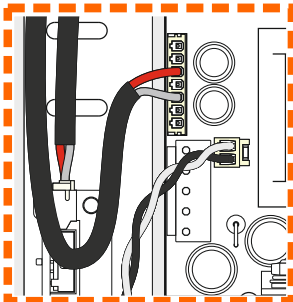
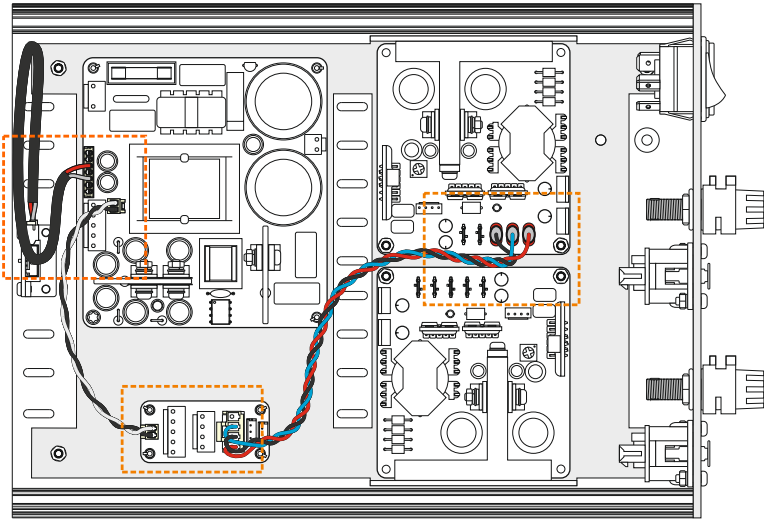

DC Supply & DC Amp-R

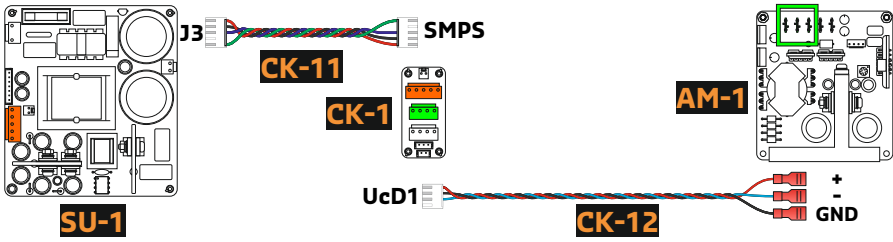

1

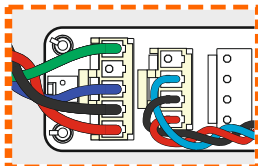
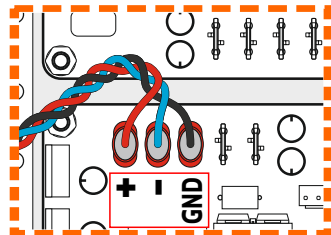
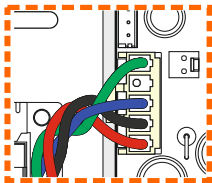
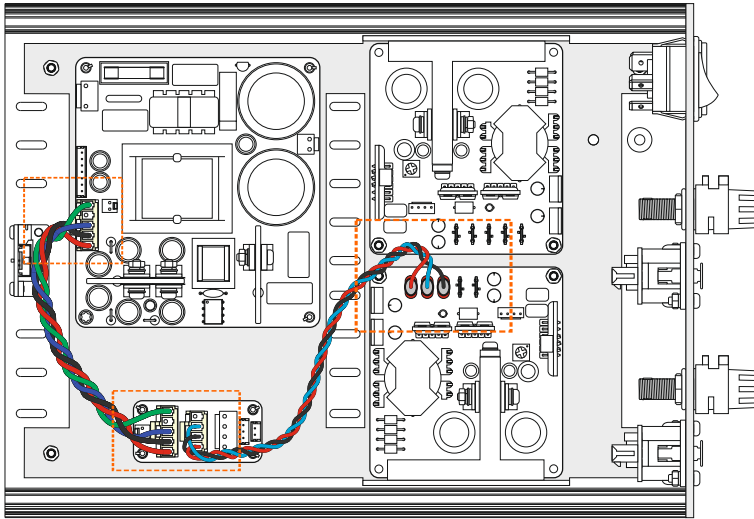

Audio Input & Amp-Enable

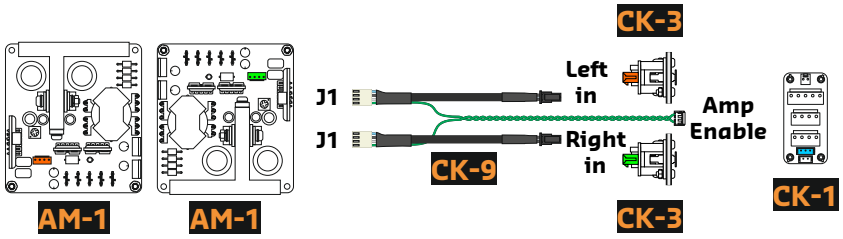

1

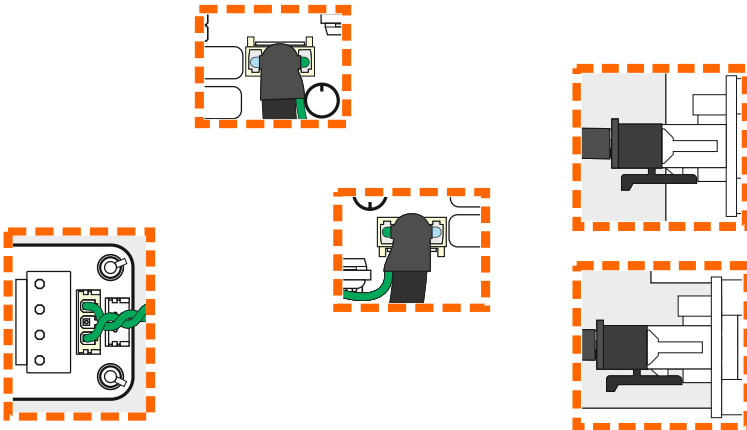
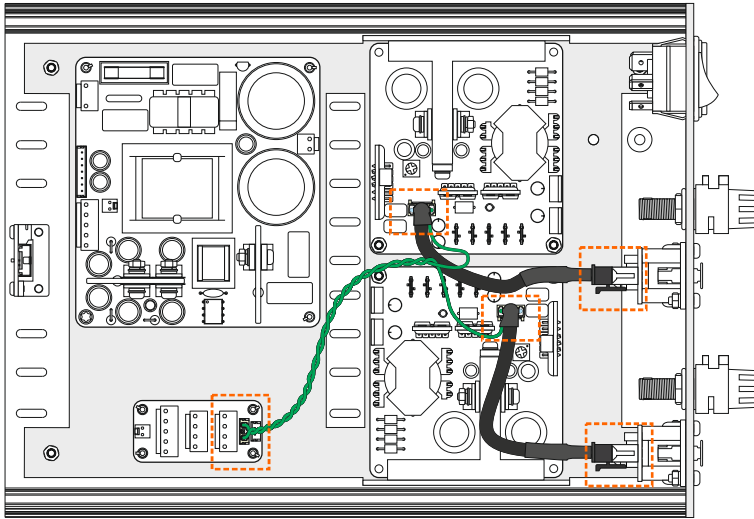

Cable Fixation

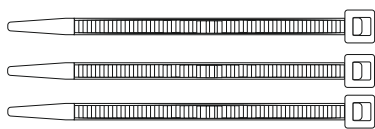

AC-4



1

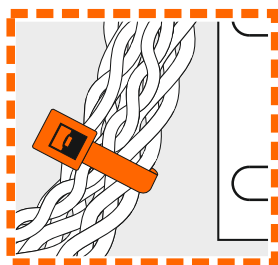
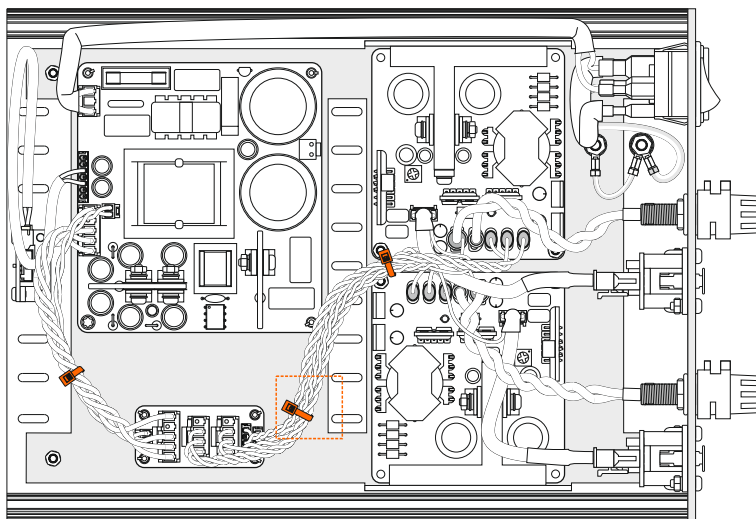

**Result:
Check all connections!!**

**115Vac
Mains**

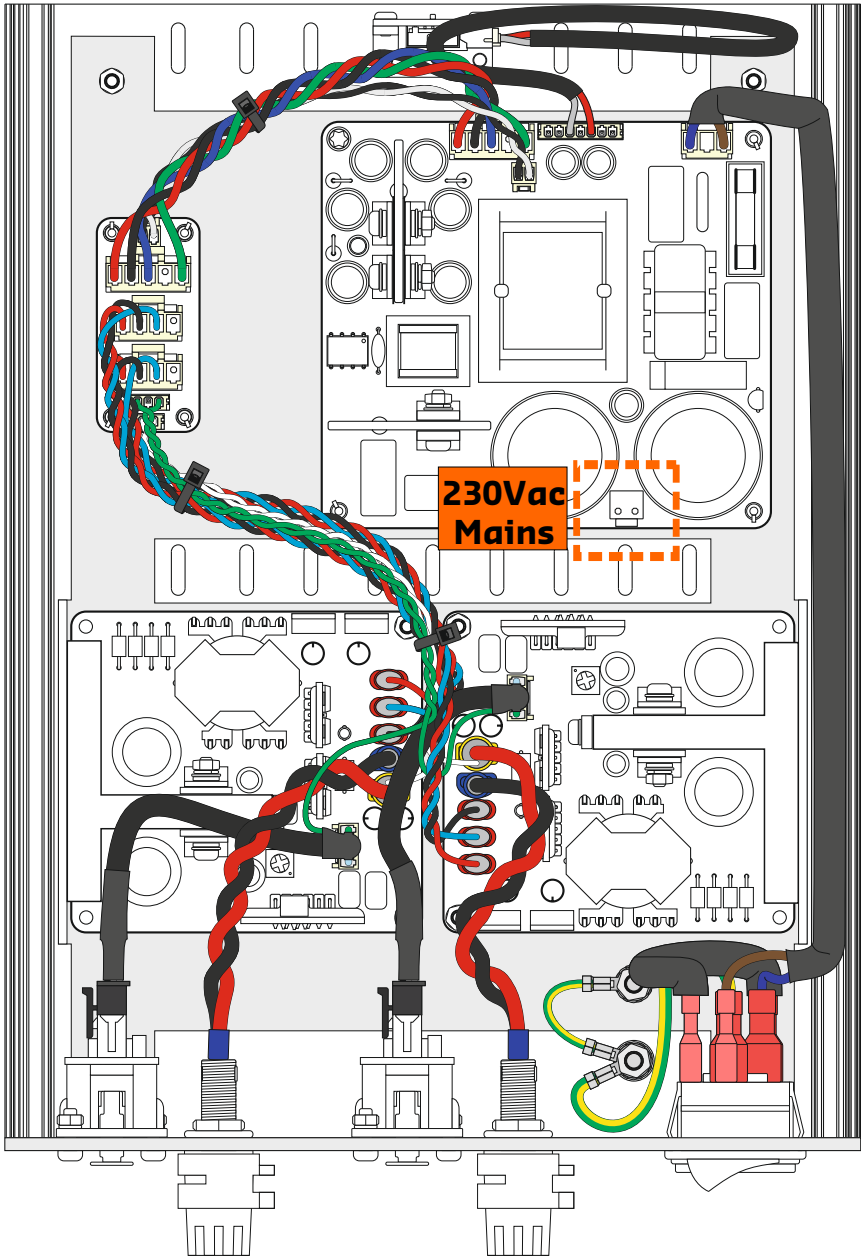
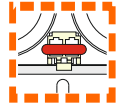

Lid



1

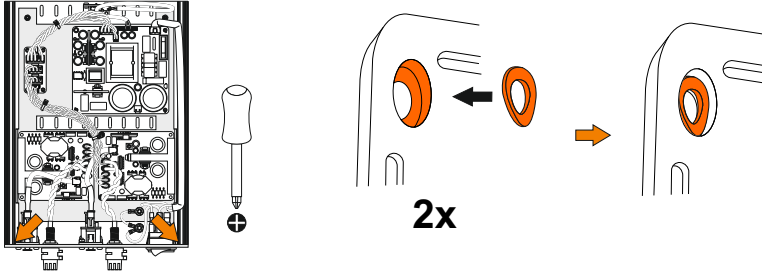

2

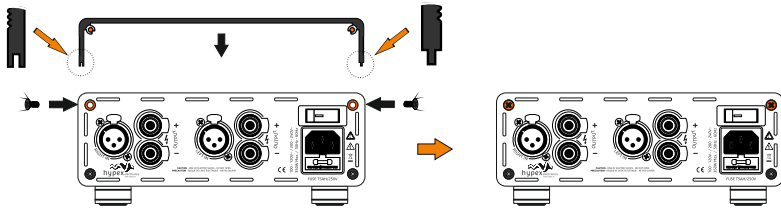

Front



1

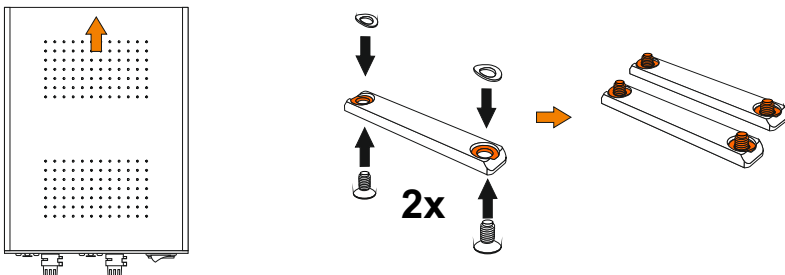

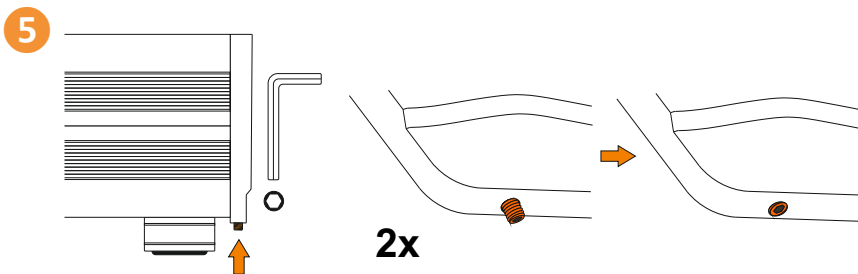
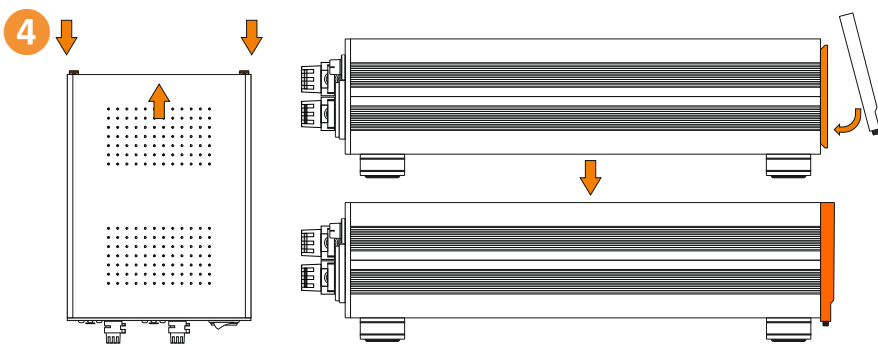
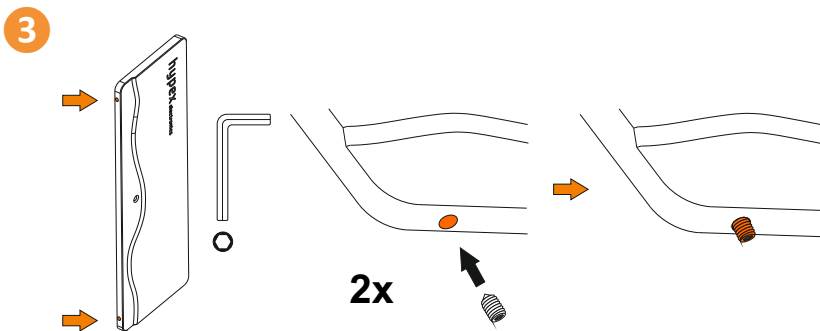
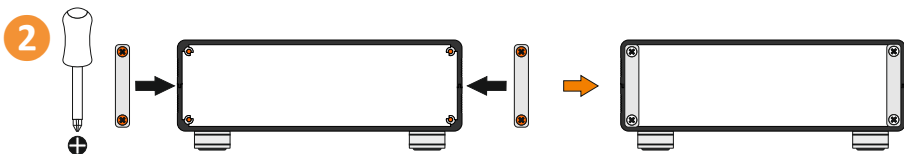

System information UcD400 stereo kit

Line input power

Low Line input voltage: 100 - 120Vac \pm 10% *

High Line input voltage: 200 - 240Vac \pm 10%

Line input frequency: 47 - 63 Hz

Connector: 3-pin IEC 250Vac, 10A male.

Input power:

Depending on load, 470W max

Input sensitivity:

200W 4 Ω @ 1.41V

Channels:

2

Technology:

UcD®

Input:

Stereo XLR

Output:

Bindingpost

Output power in 4 Ω @ < 1% THD+N:

200W**

Output power in 8 Ω @ < 1% THD+N:

200W**

*With jumper placed

**Both channels driven

Dimensions and weight

External size (WxHxD): 200 x 79 x 280 mm

(size incl feet, excl connectors)

UcD400 stereo kit: 2.85 kg

(weight for the total assembled kit)

Distortion:

0.01% @ 20Hz < f < 20kHz Pout < PR/2

Output Impedance:

20m Ω f < 1kHz

150m Ω f < 20kHz

Performance:

Power Bandwidth: 20 - 35kHz

Frequency Response: 10Hz - 50kHz

Voltage Gain: 25.5 - 26.5dB

Operation:

Load impedance: min 1 Ω

Source impedance: max 7k Ω

For more detailed information please refer to the datasheet of each individual product on our website.

Advanced system information

This information is given for reference and to guide you in connecting your DIY-kit in the correct way. Do not modify the internal wiring of the kit other than specified in the instructions.

Balanced XLR connection:

Neutrik NC3FXX-B or -BAG (female)

Neutrik NC3MXX-B or -BAG (male)

Pinout:

Pin 1: Shield

Pin 2: Positive (+ or hot)

Pin 3: Negative (- or cold)

Troubleshooting

No power

- Check the power outlet.
- The AC-Terminal fuse may be blown. Disconnect power cables and determine its status. (see page 9, chapter 5) If blown: check all AC-cables for damage and correct connections and fix problems. Replace the fuse with a corresponding one.
- The internal fuse may be blown. This fuse is not user replaceable. Please contact Hypex Electronics for more information about service and repair.

No Sound

- A protection might be triggered. Is the module overheated? Try cycling the mains power.
- Check the source signal.
- Check all the cables.

Poor sound or noise

- Check if the signal is not inverted. Inverted signals might cause one of your speakers to be out-of-phase.
- Is the amplifier clipping?
- Check all connections.

Hum

- Use balanced connections for best system performance.
- Use grounded wall sockets.

Heat

- The UcD® stereo kit will get warm/hot when used intensively, this is normal and therefore no reason for concerns.

Balanced/unbalanced connections

- The UcD® stereo kit is equipped with a balanced input only. If your source doesn't provide a balanced output but only an unbalanced output you can use one of our interconnects to connect both properly.

Frequently asked questions

Q Is there a big difference in audio quality with the Ncore® amplifier modules?

A Ncore® is Hypex leading technology, used often in high end applications. Ncore® is in basic words improved UcD® technology. UcD® products are well respected in the audio scene and already considered audiophile.

Q I do not have any technical experience, can I build this amplifier kit myself?

A Yes! even without any technical experience you can build your own amplifier kit.

Q The output power of both UcD® stereo kits is almost the same, why is this?

A Both UcD® stereo sets use a 400W SMPS. For the UcD400 this is a limiting factor for 4 Ohm loads, however it is exceptionally more powerful for 8 Ohm loads.

Q Can I drive electrostatic loudspeakers with this UcD® stereo kit?

A Yes, this UcD® stereo kit can be used for electrostatic speakers. For best results, we recommend using our Nc400 mono kits with electrostatic speakers.

Q Do I need to solder anything?

A No! we have pre-fixed everything for you, it's just a matter of assembling all the parts with a few basic tools.

Q Do you offer a pre-assembled UcD® stereo kit?

A No, we only offer a DIY building kit, we do not offer any further assembly services.

Support

We continuously work to improve your experience with our products. If you have suggestions, remarks or found a bug, please contact us.

If you have any problem with your UcD® stereo kit please consult this user guide. If this user guide is not sufficient in order to your problem please contact Hypex support department.

Do you need additional assistance with assembling your UcD® stereo kit? Watch our assembly instruction video at the product page on our website.

Visit our website!

The latest datasheets and manuals can be found there. Look into our FAQ and if you can not find the answer there, you can also contact us and we will be happy to assist you!

Limited Warranty

Hypex Electronics warrants this device for a period of two years after the original date of purchase against defects due to faulty workmanship or materials arising from Normal Use of the device. The warranty covers working parts that affect the function of the device. It does NOT cover cosmetic deterioration caused by fair wear and tear, or damage caused by accident, misuse or neglect. Any attempt to modify or take apart the device (or its accessories) will void the warranty.

If you discover a defect, notify Hypex Electronics during the warranty period. Claims under warranty must be supported by reasonable evidence that the date of the claim is within the warranty period. To validate your warranty, please keep your original purchase receipt together with these warranty conditions for the duration of the warranty period. Replacement products claimed under warranty are not entitled to renewed 2-year warranty coverage.

Date of purchase:

Revisions

Revision		Comment	Date
Doc.	HW.		
01	01xx	First release	11-12-2020

Disclaimer

Hypex Electronics BV, its affiliates, agents, and employees, and all persons acting on its or their behalf (collectively, "Hypex Electronics"), disclaim any and all liability for any errors, inaccuracies or incompleteness contained in any datasheet, user guide or in any other disclosure relating to any product.

This DIY amplifier kit is designed for use of music reproduction only. No representations are made as to fitness for other uses. Except where noted otherwise any specifications given pertain to this DIY amplifier kit only.

LIFE SUPPORT POLICY: Use of Hypex products in life support equipment or equipment whose failure can reasonably be expected to result in injury or death is not permitted except by explicit written consent from Hypex Electronics BV.

Notes



Hypex Electronics BV

Kattegat 8
9723 JP Groningen, The Netherlands
+31 50 526 4993
sales@hypex.nl
www.hypex.nl

