

High End AMT für 2-Weg Systeme. Die optimale Synthese zwischen Kleinbeschallung und High- End- HiFi. Mit 100 dB an 8 Ohm ist er ideal für Eintakttröhren-Freunde. 6 dB- Filter- optimiert.

- Sehr niedrige Verzerrungen • Sehr flache Impedanzkurve
- Tiefe Trennfrequenz • Ausgeprägte Bündelung
- 100 dB Empfindlichkeit

High End AMT for 2-way systems. The optimal synthesis between small PA and the high-end HiFi. With 100 dB at 8 ohms, it is ideal for friends of single ended tube amps. Optimized 6 dB filters.

- Very low distortion • Very flat impedance curve
- Low x-over frequency • Pronounced directivity
- 100 dB sensitivity

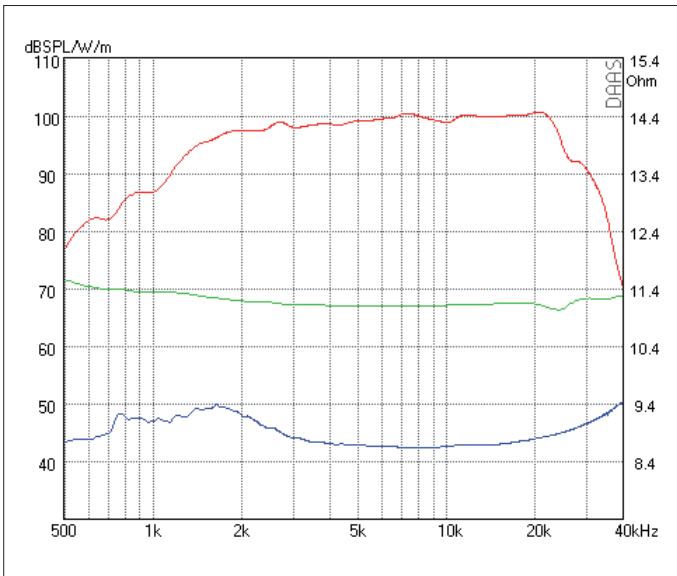

SPL 2.83 V - Phase - Impedance

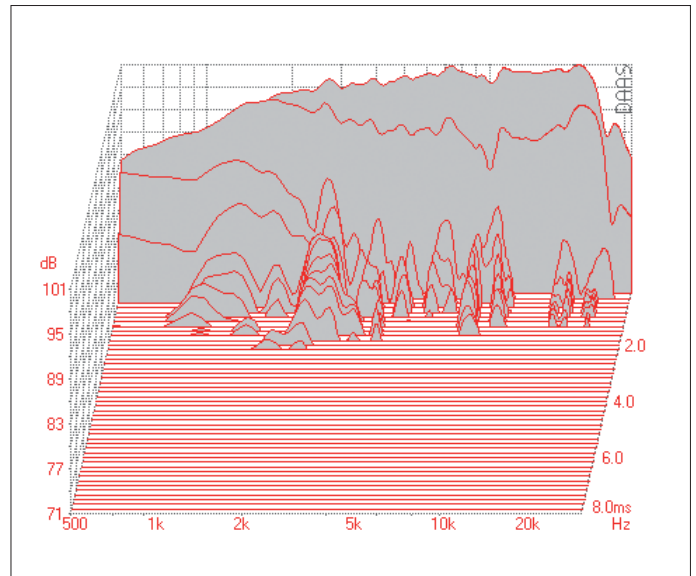

Waterfall

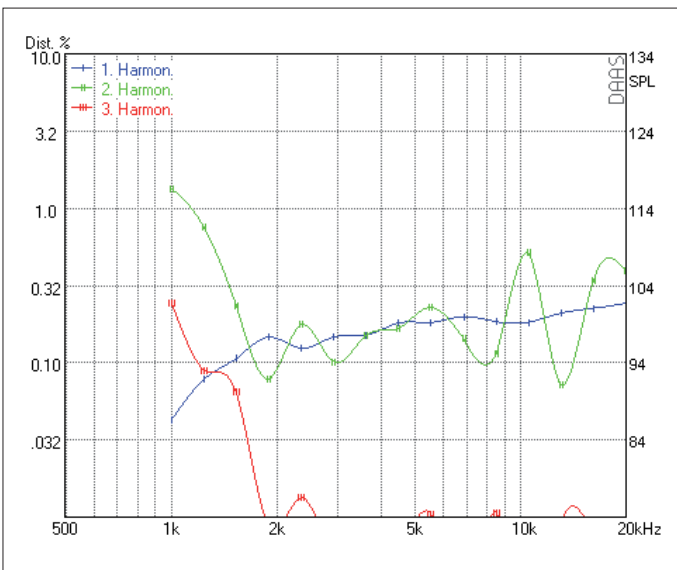

Harmonic Distortion 2.83 V

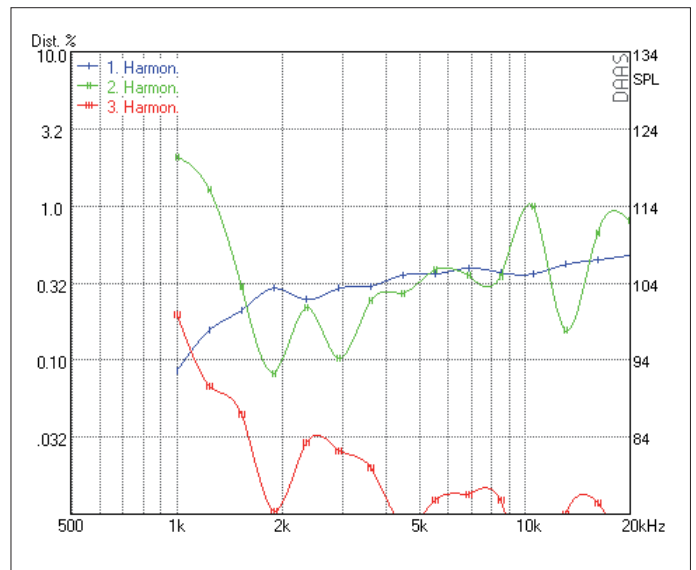

Harmonic Distortion 105 dB

RESISTANCE	NOMINAL 8 OHM		
Zo 9.3 OHM • Zmin 8.5 OHM • RE 8.5 OHM			
SENSITIVITY @ 2.83 V	100 dB		
FREQUENCY RESPONSE / -6 dB	1350 Hz – 25 kHz		
POWER HANDLING	250 W		
RESONANCE FREQUENCY / FS	1500 Hz		
RECOMMENDED CROSSOVER / 6 dB	2200 Hz		
RECOMMENDED CROSSOVER / 12 dB	2000 Hz		
DISPERSION HORIZONTAL / 15 kHz / -6 dB	60°		
DIAPHRAGM AREA	6515 mm ²		
MAGNET MATERIAL	NEODYMIUM		
FACE PLATE	3 mm Anodized Aluminum		

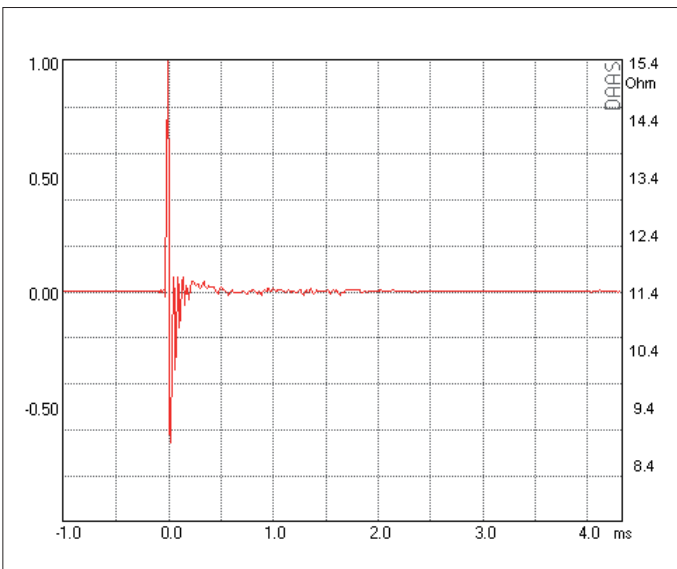
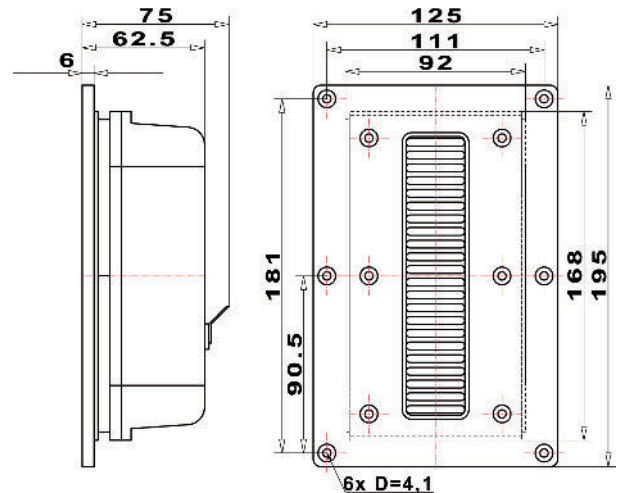

Impulse Response

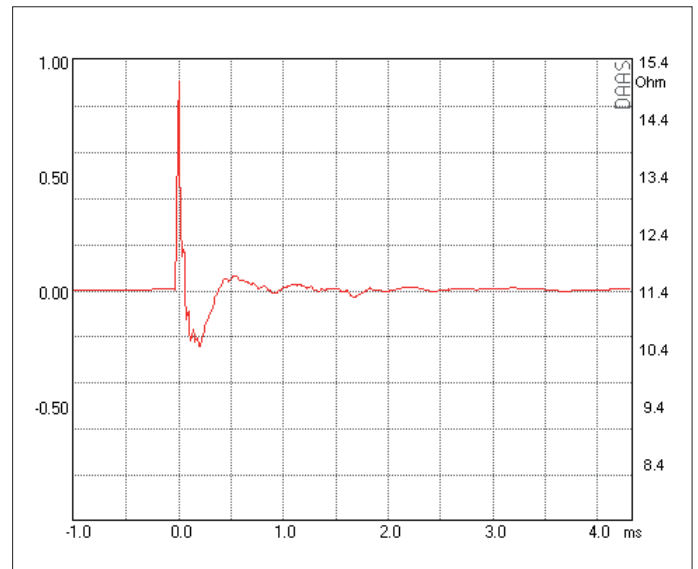

Step Response

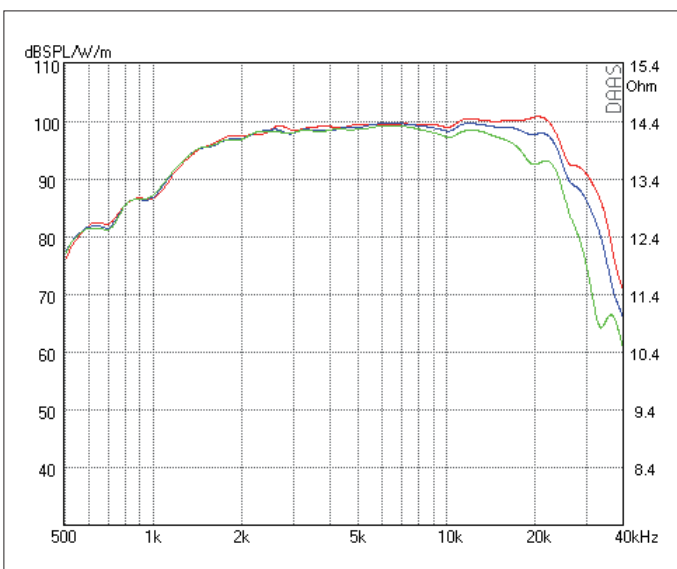

SPL HORIZONTAL 0° - 15° - 30°

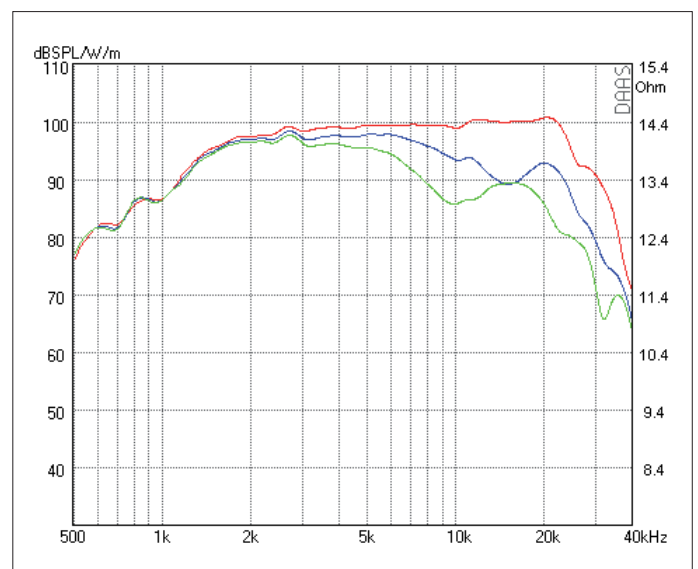

SPL VERTIKAL 0° - 5° - 15°