

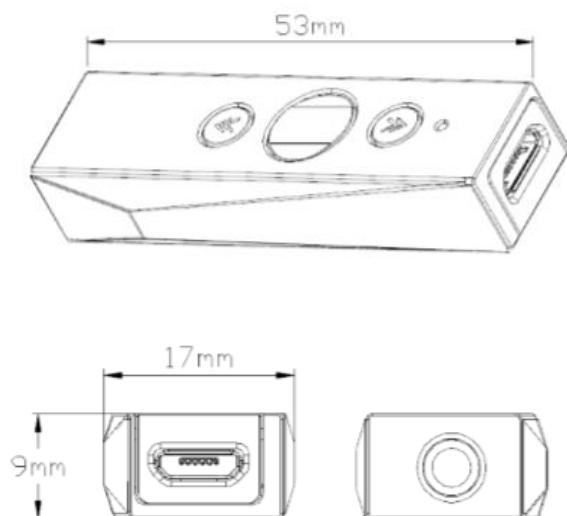

IL-DSP

USB headphone amplifier/DAC



CONTENTS

Overview	3
Connect to Android phone or tablet.....	4
Connect to computer	5
Install software	6
Download software	6
Install driver (Windows only).....	6
Install plugin - Windows	7
Install plugin - Mac	7
Windows Audio.....	8
Windows default audio device	8
ASIO	8
Mac Audio.....	9
Connect with the plugin.....	10
Adjust parametric EQ.....	11
Advanced mode	13
Biquad sample rate.....	14
Biquad calculation spreadsheet.....	14
Room EQ Wizard (REW).....	14
Saving and loading the configuration	15
Save the configuration.....	15
Load the configuration	15
Restoring to default	15
Specifications	16
Important Information.....	17
Disclaimer/Warning.....	17
Warranty Terms.....	17
FCC Class B Statement	17
CE Mark Statement.....	18
Revision history	18

OVERVIEW

The IL-DSP is a tiny USB-powered portable headphone amplifier and DAC (digital-to-analog convertor). It provides high-fidelity playback of all audio and music sources from phones, tablets and computers.

Technical performance of the IL-DSP is exemplary, with PCM digital audio playback up to 24-bit 192 kHz, 0.0007% THD and 120 dBA signal-to-noise ratio.

30 mW power output per channel is ample for IEMs and most portable headphones. High-resolution PCM and DSD formats are both supported.

The ten bands of parametric EQ are configured with miniDSP's easy-to-use computer interface. The fully adjustable peaking and shelving filters allow adjustment of the audio band from the narrowest to the broadest control ranges, with up to 16 dB boost or cut in each band. This combination of DSP power, careful selection of high-quality components and a 32-bit audiophile DAC combine to create an unparalleled portable headphone experience.

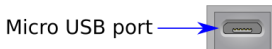
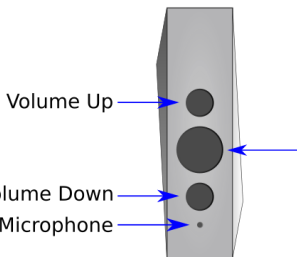
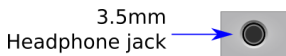

Android

- 1 click: play/pause music or answer/hang up call
- 2 clicks: skip to next song
- 3 clicks: skip back to previous song

All

- Press and hold -> LED goes dim = DSP enabled
- Press and hold -> LED goes bright = DSP disabled
- Press and hold -> LED goes off = DAC turned off (unplug and plug back in to turn on again)

CONNECT TO ANDROID PHONE OR TABLET

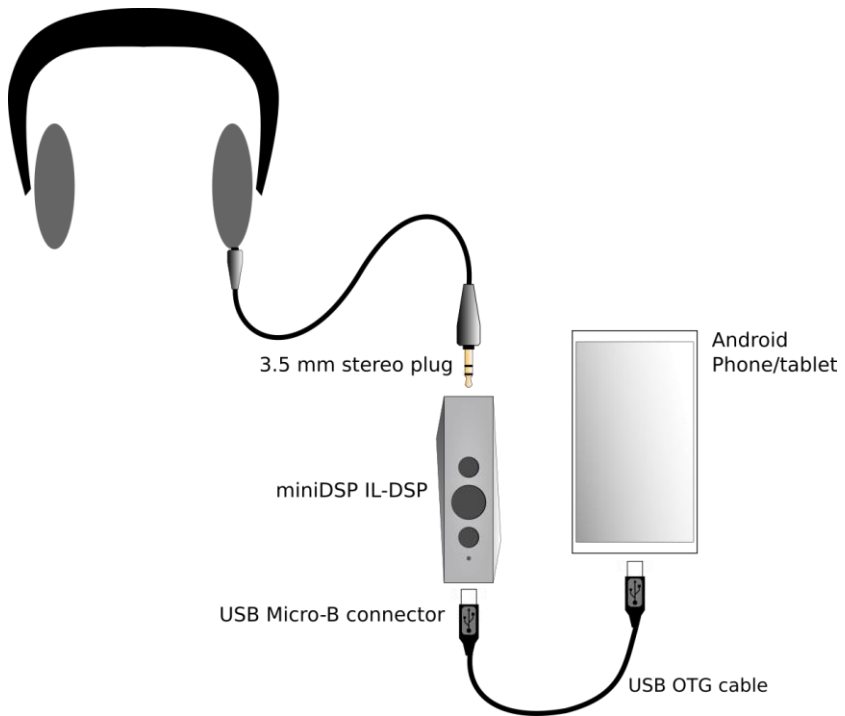

1. Use one of the supplied OTG cables to connect your phone or tablet, depending on whether your Android device has a USB-C or Micro USB B socket.
2. Connect your headphones to the 3.5mm *Headphone out* on the front of the IL-DSP.
3. Play any audio-related app on your phone/tablet. Use the up and down buttons to adjust volume for a comfortable listening level.
4. The inbuilt microphone can be used for phone calls or voice recording.
5. To adjust the EQ settings, you will need to connect the IL-DSP to your computer and install the miniDSP plugin software. See pages 6 and 7.

CONNECT TO COMPUTER

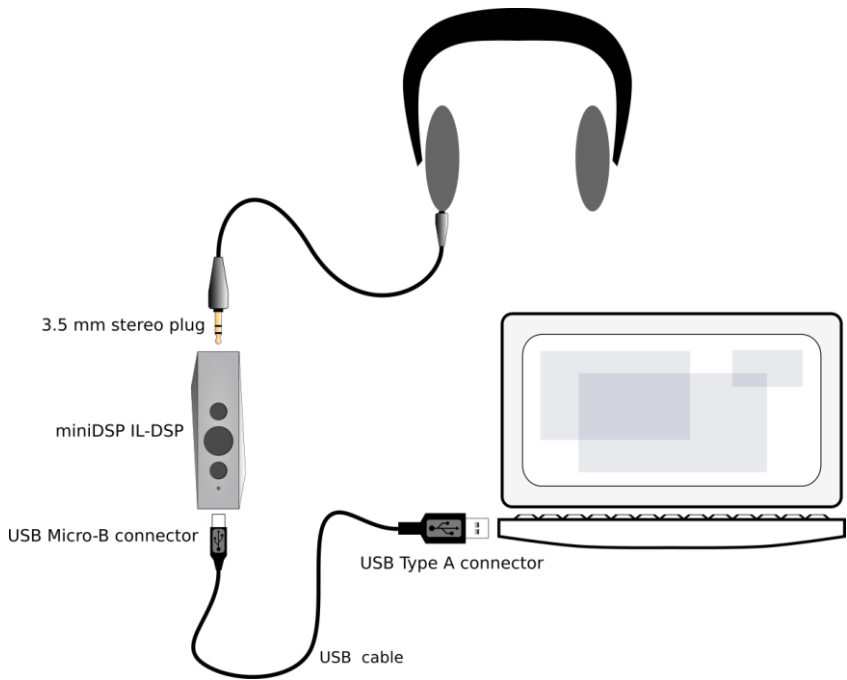

1. Connect the USB cable supplied with the IL-DSP to a USB port on your computer.
2. Connect the other end of the cable to the Micro USB-B on the IL-DSP.
3. Select the IL-DSP as the audio output device on your computer (see pages 8 and 9).
4. Run any software program that produces audio on the computer. Use the volume up and down buttons on the IL-DSP to adjust volume for a comfortable listening level.
5. To adjust the EQ settings, you will need to install the miniDSP plugin software. See pages 6 and 7.

INSTALL SOFTWARE

To adjust the parametric EQ in the IL-DSP, you will need to install the miniDSP software on your computer (Windows and Mac supported).

DOWNLOAD SOFTWARE

Log into your account on miniDSP.com. Click on your name at the top right of the window and select User Downloads:

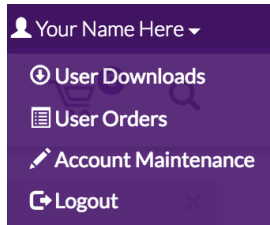

Click through to the IL-DSP section and download the IL-DSP package. After downloading, unzip it (on Windows, right-click and select “Extract All...”; on Mac, double-click).

INSTALL DRIVER (WINDOWS ONLY)

1. Connect the IL-DSP to the computer with the USB cable.
2. Go to the **WinDrivers** folder of the software download and double-click on the appropriate installer:
 - **miniDSP_UAC2_v2.29.3_ForWinXP_Vista.exe** for Windows XP and Vista
 - **miniDSP_UAC2_v4.47.0_ForWin7_8_10.exe** for Windows 7, 8, and 10

The version number embedded in the filename may be different. We recommend accepting the default installation location.

INSTALL PLUGIN - WINDOWS

1. Go to the **Plugins** folder of the software download and then to the **Windows** folder.
2. Double-click on the **IL-DSP.exe** installer program to run it. We recommend that you accept the default installation settings.

INSTALL PLUGIN - MAC

1. Go to the **Plugins** folder of the software download and then to the **Mac** folder.
2. Right-click on the **IL-DSP.pkg** installer program. Move the mouse over the “Open With” item and then click on “Installer (default).”

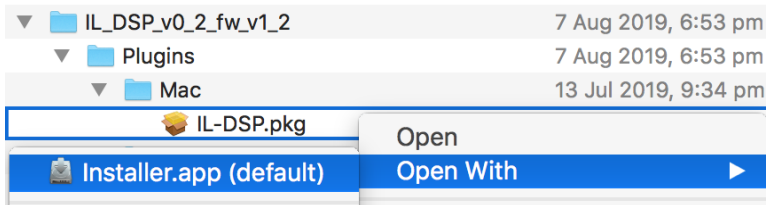

3. If the following window appears, click on “Open.” We recommend that you accept the default installation settings.



WINDOWS AUDIO

Note: playing USB audio from Windows requires that the UAC driver package be installed first (page 6).

WINDOWS DEFAULT AUDIO DEVICE

Set the IL-DSP as the default audio output device. Open the Windows Control Panel and navigate to the Audio Devices section. On the Playback tab, select “IL-DSP” and click on the “Set Default” button.

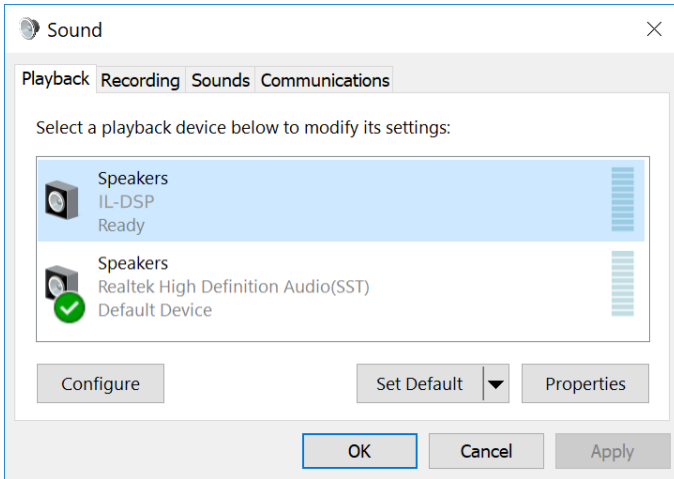

ASIO

If your audio application program supports ASIO audio drivers, we recommend selecting the miniDSP ASIO Driver in the settings of that program. This typically allows the program to automatically change sample rate. For example, in JRiver Media Center:

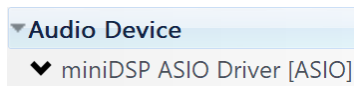

MAC AUDIO

Set the IL-DSP as the default audio output device. Open System Preferences and on the Sound page, select the IL-DSP as the Output device.

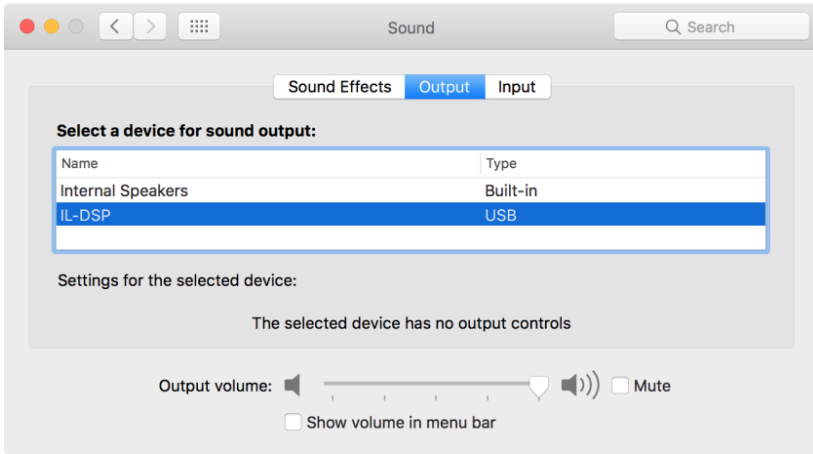

Individual audio playback programs may allow the IL-DSP to be selected for audio output independently of the system default.

To select the sample rate that the computer uses to send audio to the IL-DSP, open the Audio MIDI Setup program and click on **Format**.

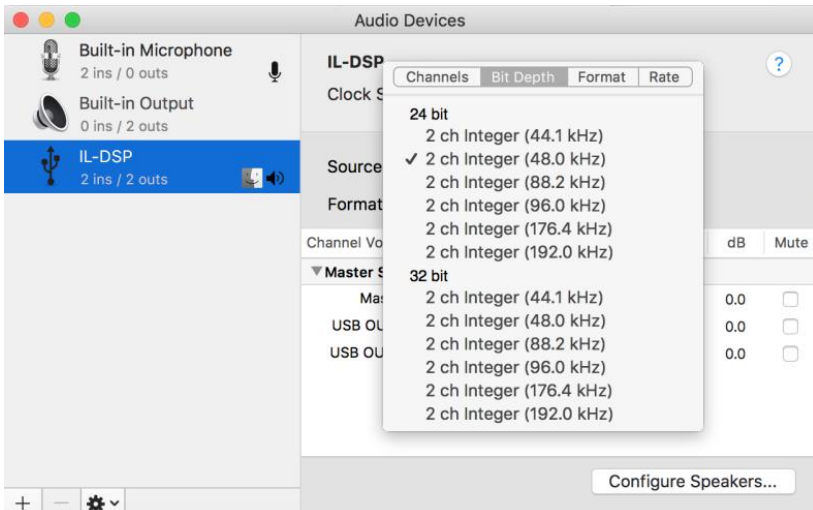

CONNECT WITH THE PLUGIN

With the IL-DSP connected to your computer, start the plugin:

- On Windows, locate the plugin in the Start menu. To make it easier to run in future, right-click on its icon in the taskbar and select “Pin to taskbar.”
- On MacOS, locate the plugin in the Applications -> miniDSP folder. To make it easier to run in future, right-click on its dock icon and select Options -> Keep in Dock.

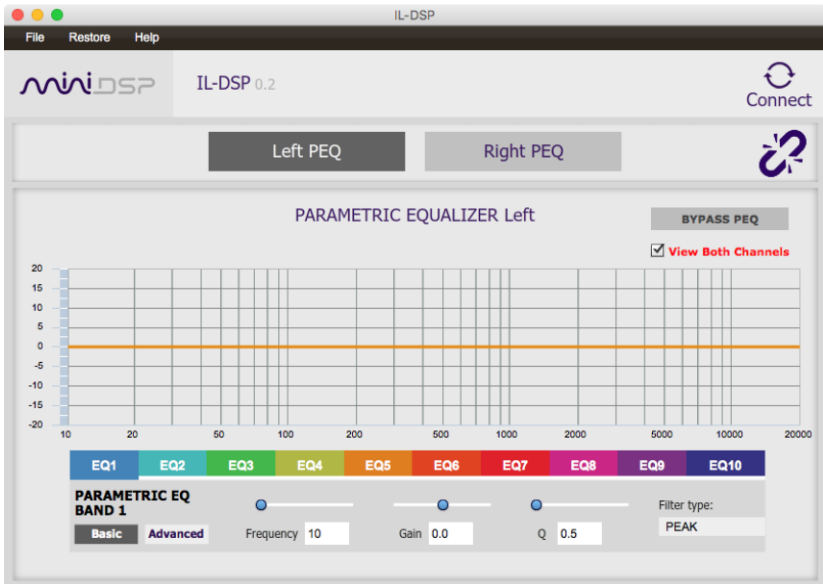

Click on the Connect button:



Click on Synchronize Config:

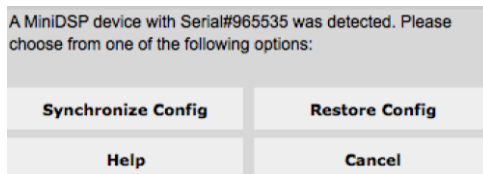

ADJUST PARAMETRIC EQ

There are three types of parametric EQ filter. The filter type is selected towards the lower right of the settings window:

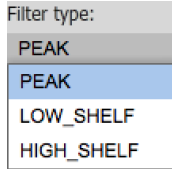

There are ten bands of EQ. Select one by clicking on it:



There are three parameters that control each filter's frequency response:

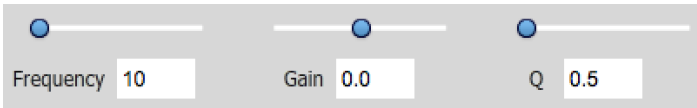

Frequency

This is the center frequency of the filter. For PEAK, it is where maximum boost or cut is. For HIGH_SHELF and LOW_SHELF filter types, it is where the gain is half-way to the set value.

Gain

This is the maximum gain of the filter, in dB. If gain is positive, the filter boosts; if gain is negative, the filter cuts.

Q

This control the "sharpness" of the filter. For PEAK filters, a low Q gives a broad boost or cut. For HIGH_SHELF and LOW_SHELF, a higher Q gives a steeper transition to the shelf.

To control both channels at the same time, click on the Link icon:



You can switch between EQ and no EQ with the Bypass EQ button:



PEAK

This filter creates a dip or a peak in the frequency response. If the gain is positive, the filter boosts a frequency region around the specified frequency. See the left side of this graph:

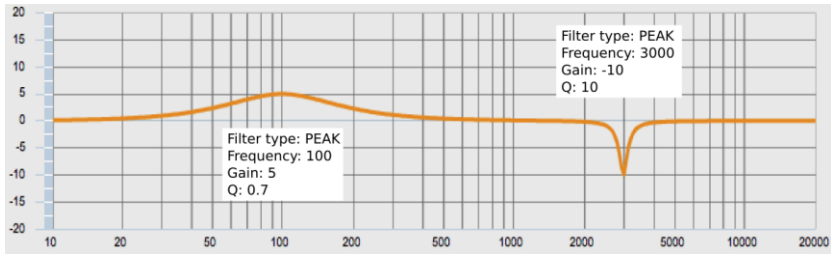

If the gain is negative, the filter cuts a frequency range. On the right side above we have used negative gain, with a narrow frequency range set by using a high value of Q.

LOW_SHELF and HIGH_SHELF

A low shelf filter reduces the gain below the specified frequency. On the left side of the graph below, we have used a low shelf filter with positive gain to provide a gentle bass boost:

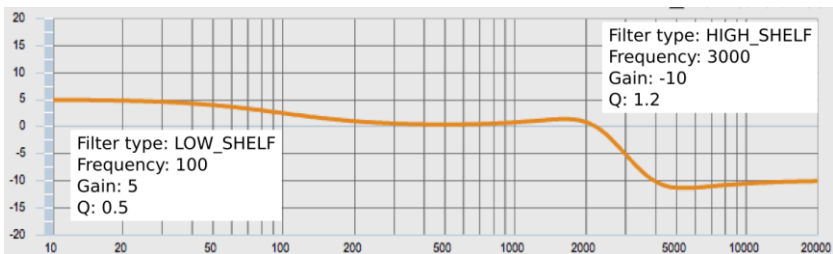

On the right side, we have used a high shelf filter with negative gain to cut high frequencies by about 10 dB. The Q shown is higher than you usually use for this type of filter.

ADVANCED MODE

Click on the **Advanced** button to switch an EQ band to Advanced mode.



In Advanced mode, each filter band is specified by the *biquad coefficients* of that filter. This is a set of five numbers that directly specifies the numerical computations performed by the filter. The coefficients must be generated by a filter design program (see next page).

Biquad coefficients can be entered or pasted directly into the user interface:

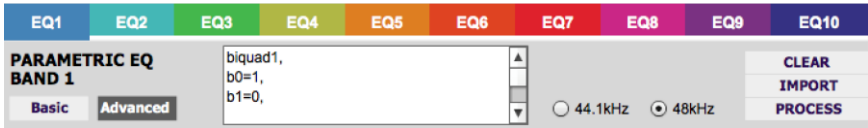

The format of the text entry field is as follows:

```
biquad1,  
b0=0.998191200483864,  
b1=-1.9950521500467384,  
b2=0.996920046761057,  
a1=1.9950521500467384,  
a2=-0.9951112472449212
```

After entering or pasting in the coefficients for a band, press the **Process** button.

Biquads can also be imported from a file. The file can contain from one to ten biquads in the format given above. Note that commas must separate each biquad, and the last line of the file should not end with a comma. Click on the **Import** button to import a biquad file.

- Biquads are always imported starting from filter band EQ1, regardless of the numbering in the biquad file.
- The same number of biquads as in the file are imported. However, some programs (e.g. REW) generate a file with ten biquads even if only some have coefficients.

BIQUAD SAMPLE RATE

Biquad coefficients must be calculated by a filter design program. Any program that calculates biquad coefficients must do so at a specific sample rate. The IL-DSP operates internally at two different sample rates:

- 44.1 kHz if the input sample rate is 44.1, 88.2 or 176.4 kHz
- 48 kHz if the input sample rate is 48, 96 or 192 kHz

Therefore, unless you are sure that you only will be playing back at one of the above sets of sample rates,¹ you will need to calculate and load two sets of biquad coefficients, one at 44.1 kHz and one at 48 kHz.

To load biquads at a specific sample rate, simply select the appropriate radio button and then use the **Process** or **Import** button as described on the previous page.

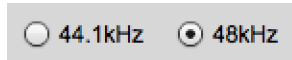

BIQUAD CALCULATION SPREADSHEET

The community-developed biquad calculation spreadsheet allows biquad coefficients for many filter types to be calculated, including notch filters, Linkwitz transforms, and filters with arbitrary Q-factor. Access this spreadsheet here (requires Microsoft Excel):

- [All digital coefs v1-20101026.zip](#) (on minidsp.com)

ROOM EQ WIZARD (REW)

Room EQ Wizard (REW) is a free acoustic measurement and analysis tool, available for Windows, Mac and Linux. It can generate a bank of parametric EQ biquads based on a measurement. Room EQ Wizard can be downloaded here:

- <http://www.roomeqwizard.com/#downloads>

For guidance on using this feature, please refer to this app note:

- [Auto EQ with REW](#)

¹ Android devices only output at one sample rate and convert all other sample rates. Typically, Android devices output at 48 kHz although we have also seen 96 kHz. In any case, loading biquad coefficients at 48 kHz only should suffice for an Android device.

SAVING AND LOADING THE CONFIGURATION

The complete set of data that controls the DSP processor is called a *configuration*. This includes the parametric EQ and the link setting. It does not include the volume setting.

SAVE THE CONFIGURATION

To save the current preset to a file, drop down the File menu and select **Save** then “Save current configuration to computer.” Select the location in the file system and enter the desired file name, then click Save.

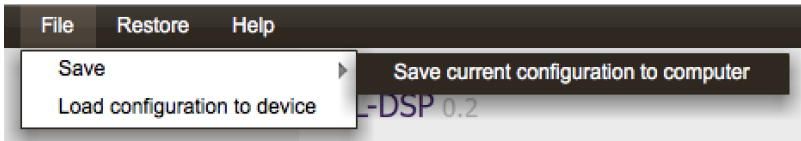

It is recommended that you save your configuration to a file to ensure that you do not lose them if you inadvertently reset the IL-DSP or upgrade your computer.

LOAD THE CONFIGURATION

To load the configuration from a file, drop down the File menu and select “Load configuration to device.” Locate the configuration file and click Open.

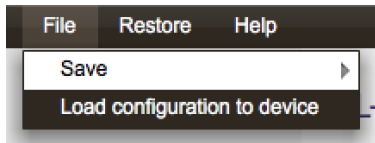

RESTORING TO DEFAULT

To restore the configuration to its factory default values, drop down the Restore menu and select Current configuration.

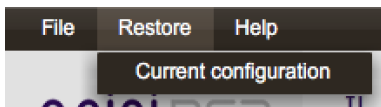

SPECIFICATIONS

Digital specifications

Audio resolution	Up to 24 bits
Input sample rates (PCM)	44.1, 48, 88.2, 96, 176.4, 192 kHz
Direct-Stream Digital (DSD) input	DSD64/DSD128 (no DSP processing in DSD mode)
Internal DSP processing	44.1 or 48 kHz (depends on input sample rate)

Analog specifications

Frequency response	20-20 kHz, +/-0.2 dB
Signal-to-noise ratio	120 dB (32 Ω , 1 kHz, A-weighted, digital in 0 dB)
THD + Noise	0.0007% (32 Ω , 1 kHz, 30 mW + 30 mW, mid gain)
Power output	100 30 mW + 30 mW (32 Ω , 1 kHz, digital in 0 dB)

Physical characteristics

Dimensions (WxDxH)	53 x17 x 9 mm
Weight	50 g

IMPORTANT INFORMATION

DISCLAIMER/WARNING

miniDSP cannot be held responsible for any damage that may result from the improper use of this product or incorrect configuration of its settings. As with any other product, we recommend that you carefully read this manual and other technical notes to ensure that you fully understand how to operate this product. The miniDSP audio processor is a powerful tool, and misuse or misconfiguration, such as incorrectly set gains or excessive boost, can produce signals that may damage your audio system.

As a general guideline, you should perform the initial configuration of the miniDSP audio processor before enabling audio through any connected output device or amplification. Doing so will help ensure that the software is correctly configured.

Finally, note that the miniDSP audio processor is a very flexible device, and many of the questions we receive at the tech support department are already answered in this user manual and in the online [application notes](#) on the miniDSP.com website. So please take the time to carefully read this user manual and the online technical support. Thanks for your understanding!

WARRANTY TERMS

miniDSP Ltd warrants this product to be free from defects in materials and workmanship for a period of one year from the invoice date. Our warranty does not cover failure of the product due to incorrect connection or installation, improper or undocumented use, unauthorized servicing, modification or alteration of the unit in any way, or any usage outside of that recommended in this manual. If in doubt, contact miniDSP prior to use.

FCC CLASS B STATEMENT

This device complies with Part 15 of the FCC Rules. Operation is subject to the following two conditions:

This device may not cause harmful interference.

This device must accept any interference received, including interference that may cause undesired operation.

Warning: This equipment has been tested and found to comply with the limits for a Class B digital device, pursuant to Part 15 of the FCC Rules. These limits are designed to provide reasonable protection. This equipment generates, uses and can radiate radio frequency energy and, if not installed and used in accordance with the instructions, may cause interference to radio communications. However, there is no guarantee that interference will not occur in a particular installation. If this equipment does cause harmful interference to radio or television reception, which can be determined by turning the equipment off and on, the user is encouraged to try to correct the interference by one or more of the following measures:



Reorient or relocate the receiving antenna.

Increase the separation between the equipment and receiver.

Connect the equipment into an outlet on a circuit different from that to which the receiver is connected.

Consult the dealer or an experienced radio/TV technician for help.

Notice: Shielded interface cable must be used in order to comply with emission limits.

Notice: Changes or modification not expressly approved by the party responsible for compliance could void the user's authority to operate the equipment.

CE MARK STATEMENT

The IL-DSP has passed the test performed according to European Standard EN 55022 Class B.

REVISION HISTORY

Revision	Description	Date
V0.1	Preliminary version	8 August 2019
V0.2	Preliminary for review	10 August 2019