

SPEAKER PROTECTION KIT

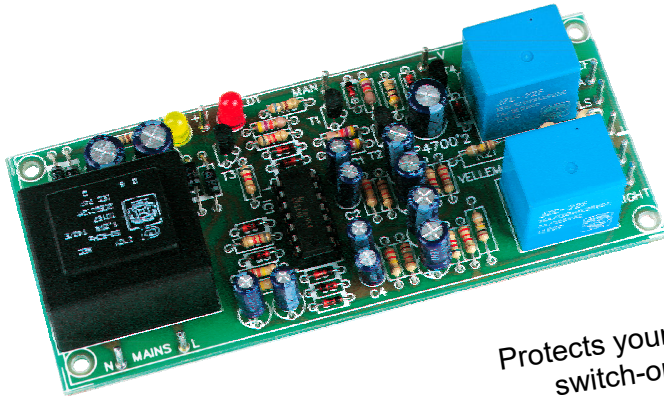

K4700

Protects your precious speakers against
switch-on clicks and DC current.



VELLEMAN NV

Legen Heirweg 33

9890 Gavere

Belgium Europe

www.velleman.be

www.velleman-kit.com

Features

This stereo loudspeaker protection will protect the loudspeakers against the switch-impulsions and the direct current component on the output of the connected amplifier.

- Suitable for:
- * Amplifiers with symmetrical power supply
 - * Amplifiers with asymmetrical power supply.

Specifications :

- Switch-delay: ± 6 seconds
- DC protection: +1V/-1V
- Max. input voltage: 200Vpp + DC
- Max. switching current: 10A
- LED indication for: WAIT (switch-on delay) and ERROR (DC on speaker output)
- Supply voltage: 220VAC
- PCB dimensions: 55 x 125mm (2.2" x 4.9")

1. Assembly (Skipping this can lead to troubles !)

Ok, so we have your attention. These hints will help you to make this project successful. Read them carefully.

1.1 Make sure you have the right tools:

- A good quality soldering iron (25-40W) with a small tip.
- Wipe it often on a wet sponge or cloth, to keep it clean; then apply solder to the tip, to give it a wet look. This is called 'thinning' and will protect the tip, and enables you to make good connections. When solder rolls off the tip, it needs cleaning.
- Thin rosin-core solder. Do not use any flux or grease.
- A diagonal cutter to trim excess wires. To avoid injury when cutting excess leads, hold the lead so they cannot fly towards the eyes.
- Needle nose pliers, for bending leads, or to hold components in place.
- Small blade and Phillips screwdrivers. A basic range is fine.

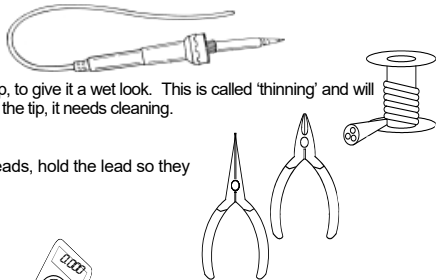

For some projects, a basic multi-meter is required, or might be handy



1.2 Assembly Hints :

- ⇒ Make sure the skill level matches your experience, to avoid disappointments.
 - ⇒ Follow the instructions carefully. Read and understand the entire step before you perform each operation.
 - ⇒ Perform the assembly in the correct order as stated in this manual
 - ⇒ Position all parts on the PCB (Printed Circuit Board) as shown on the drawings.
 - ⇒ Values on the circuit diagram are subject to changes.
 - ⇒ Values in this assembly guide are correct*
 - ⇒ Use the check-boxes to mark your progress.
 - ⇒ Please read the included information on safety and customer service
- * Typographical inaccuracies excluded. Always look for possible last minute manual updates, indicated as 'NOTE' on a separate leaflet.

1.3 Soldering Hints :

1- Mount the component against the PCB surface and carefully solder the leads

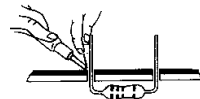

2- Make sure the solder joints are cone-shaped and shiny

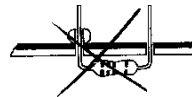
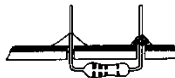

3- Trim excess leads as close as possible to the solder joint

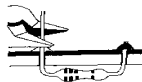

AXIAL COMPONENTS ARE TAPED IN THE CORRECT MOUNTING SEQUENCE !

REMOVE THEM FROM THE TAPE ONE AT A TIME !

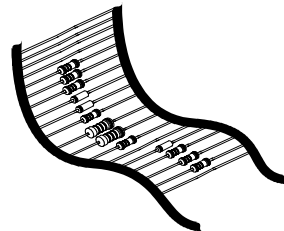

1. Diodes. Watch the polarity !

- D1 : 1N4148
- D2 : 1N4148
- D3 : 1N4148
- D4 : 1N4148
- D5 : 1N4148
- D6 : 1N4148
- D7 : 1N4148
- D8 : 1N4148
- D9 : 1N4148
- D10 : 1N4148

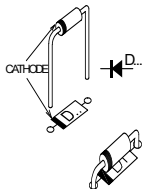

3. Diodes. Watch the polarity !

- D11 : 1N4007
- D12 : 1N4007
- D13 : 1N4007
- D14 : 1N4007

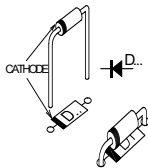

2. Zenerdiode. Watch the polarity !

- ZD1 : 6V8

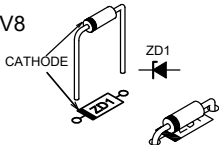

4. Resistor

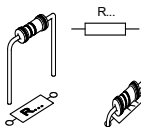

- R1 : 3K3 (3 - 3 - 2 - B)
- R2 : 3K3 (3 - 3 - 2 - B)
- R3 : 8K2 (8 - 2 - 2 - B)
- R4 : 8K2 (8 - 2 - 2 - B)
- R5 : 8K2 (8 - 2 - 2 - B)
- R6 : 8K2 (8 - 2 - 2 - B)
- R7 : 8K2 (8 - 2 - 2 - B)

- R8 : 330K (3 - 3 - 4 - B)
- R9 : 330K (3 - 3 - 4 - B)
- R10 : 330K (3 - 3 - 4 - B)
- R11 : 330K (3 - 3 - 4 - B)
- R12 : 18K (1 - 8 - 3 - B)
- R13 : 18K (1 - 8 - 3 - B)
- R14 : 47K (4 - 7 - 3 - B)
- R15 : 47K (4 - 7 - 3 - B)
- R16 : 47K (4 - 7 - 3 - B)
- R17 : 47K (4 - 7 - 3 - B)
- R18 : 47 (4 - 7 - 0 - B)
- R19 : 680 (6 - 8 - 1 - B)
- R20 : 680 (6 - 8 - 1 - B)

5. Metal film resistor

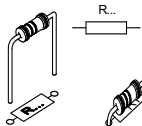

- R21 : 100K (1 - 0 - 4 - B - 9)
- R22 : 100K (1 - 0 - 4 - B - 9)

6. IC socket, Watch the position of the notch !

- IC1 : 14P

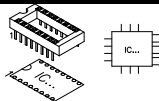

7. Transistors

- T1 : BC547B
- T2 : BC547B
- T3 : BC547B
- T4 : BC517

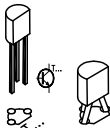

8. PCB tabs.

- MAINS (N - L)
- +V
- MAN
- V
- GND



- PA } LEFT
- LS }
- PA } RIGHT
- LS }



9. Leds. Watch the polarity!

- LD1 : Red (ERROR)
- LD2 : Yellow (WAIT)

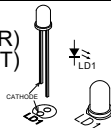

10. Electrolytic Capacitor. Watch the polarity !

- C1 : 1µF
- C2 : 1µF
- C3 : 1µF
- C4 : 1µF
- C5 : 1µF
- C6 : 1µF
- C7 : 100µF
- C8 : 100µF
- C9 : 100µF
- C10 : 100µF
- C11 : 220µF
- C12 : 470µF
- C13 : 470µF

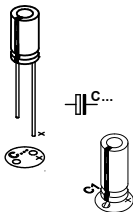

11. 1W vertical resistors

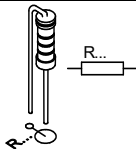

If the amplifier to which the module is to be connected has a simple power supply (asymmetrical supply), i.e. an amplifier with output-elcos, the following resistances has to be mounted:

- R23 : 1K2 (1 - 2 - 2 - B)
- R24 : 1K2 (1 - 2 - 2 - B)
- R25 : 1K2 (1 - 2 - 2 - B)
- R26 : 1K2 (1 - 2 - 2 - B)

ATTENTION: if the involved amplifier has a symmetrical power supply, those resistances may NOT be mounted!

12. Relays

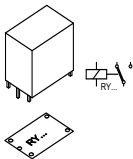

- RY1 : VR15M121C (12VDC - 15A - 1C)
- RY2 : VR15M121C (12VDC - 15A - 1C)

 **Cover the wide connecting broad leads with solder.**

13. Transformer

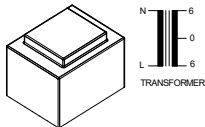

- Transfo (1,2VA - 2 x 6V / 2 x 0,1A)

14. IC. Watch the position of the notch!

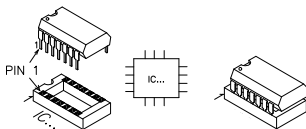

- IC1 : LM324

 **CHECK THE ENTIRE MODULE PROFOUNDLY ONCE AGAIN.**

 **CHECK IF ALL SOLDERINGS ARE CORRECT AND THAT THERE ARE NO SHORT-CIRCUITS!**

15. Testing

Connect a net-cord to the MAINS, connect the module to the net and check if after approx. +/-6 sec. the yellow LED 'WAIT' extinguishes; at the very same moment the LED is extinguishing, one should hear the clack of the relais switching.

Testing the Left channel :

- Connect the point PA of the left channel to the point -V (figure 1.0); the red LED 'ERROR' should now be lightening together with the yellow LED 'WAIT'.
- When the connection is interrupted again (figure 2.0), the red LED should extinguish and after approx. +/- 6 sec. the yellow LED as well.

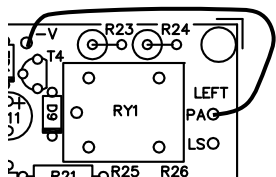

Fig. 1.0

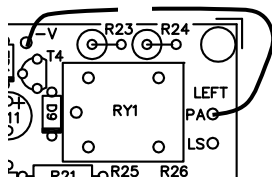

Fig. 2.0

Repeat this testing procedure by connecting the point PA to the point +V.

Testing the right channel :

- ❑ Connect the point PA of the right channel to the point -V (figure 3.0); the red LED 'ERROR' should now be lightening together with the yellow LED 'WAIT'.
- ❑ When the connection is interrupted again (figure 4.0), the red LED should extinguish and after approx. +/- 6 sec. the yellow LED as well.

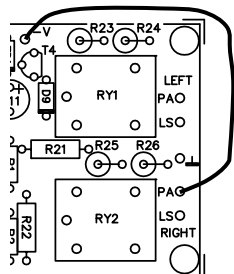

Fig. 3.0

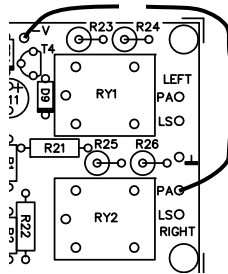

Fig. 4.0

Repeat this testing procedure by connecting the point PA to the point +V.



The module is now ready for being connected definitively to the amplifier.

16. Connection

First find a proper place to install the protection module (f.i. against the back-side of the housing).

Realise the following connections:

MAINS: this connection has to be linked to the NET-connection of the transformer in the amplifier, i.e. AFTER the net-switch!

PA: connect this point to the speaker-output of the amplifier, respectively for the left and the right signal (fig 5.0). In case a bridge-amplifier (fig 6.0) is being used, there ought to be two "hot" connections here.

MASS: this point has to be connected to the mass of the amplifier.

LS: to this point the left resp. right loud speaker is to be connected.

To disconnect the loudspeakers manually, realise the following connections:

Install a switch between the points -V and MAN; when the switch is shut the speakers will be disconnected permanently, when opening the switch again after approx. +/-6 sec the speakers will be reconnected as well.

REMARK. In case of amplifiers with asymmetrical power supply (i.e. having output-elcos and the resistances R23 to R26) of more than 300W/4 Ohm or 150W/8 Ohm, it is not recommandable to disconnect the speakers at full power during a longer period, because the just mentioned resistances could burn. In case the protection module is being used on a bridge-amplifier with asymmetrical power supply, the diodes D7 and D8 should not be mounted; in this case the DC-protection should not be functioning anymore because the voltage-reference of the protection-module is now opposed to the mass.

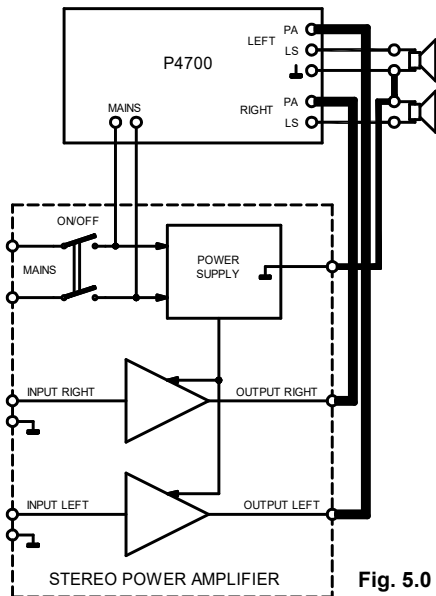

Fig. 5.0

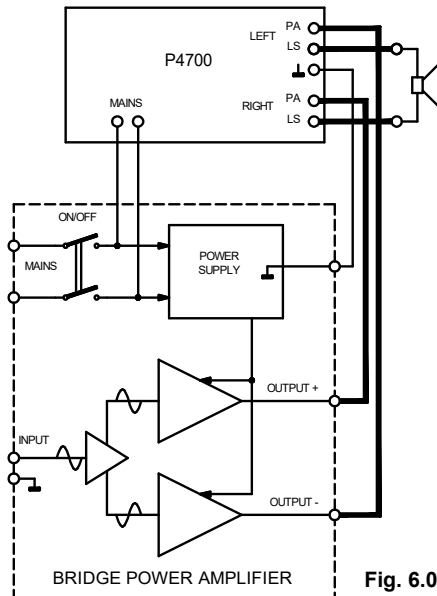
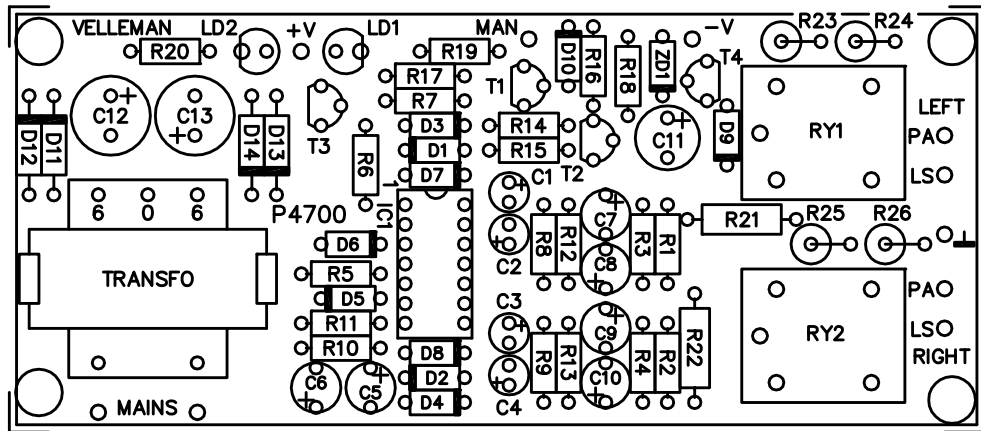
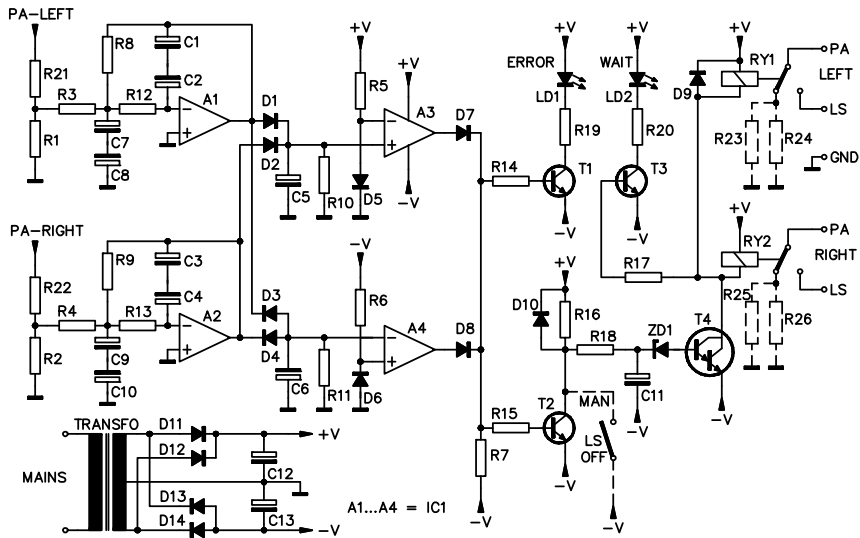

Fig. 6.0

17. PCB layout.



18. Diagram





VELLEMAN NV
Legen Heirweg 33, B-9890 GAVERE
Belgium (Europe)

 @velleman_RnD

