

B|ACOUSTICS

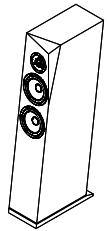

Rinjani | User Manual



Technical Specifications:

Frequency range	: 42-25000 Hz +/-3 dB
Sensitivity (2.83V / 1m)	: 89 dB
Nominal impedance	: 4Ω
Max SPL	: 107 dB
Recommended amplifier	: 50-200 W
Cross-over frequency	: 3000 Hz
Speaker type	: 2.5-way Floor Stand
Enclosure type	: Bass reflex
Port tuning frequency	: 35.5 Hz

Drive Units:

- High frequency driver : SATORI TW29R / TW29R-B
(29 mm soft ring dome)
- Low frequency drivers : 2 x 6.5" SATORI MW16P-8 / MW16PNW-8
(advanced midwoofer)

Cabinet:

18 mm MDF

Dimensions (H x W x D) : 1009 x 190 x 464 mm / 45.87 x 12.41 x 20.47 inch

Net Weight (pair):

- Cabinet only : 18.49 kg / 40.76 lb
- Full assembly : 22.42 kg / 49.43 lb

Special Features:

- Advanced high-end drivers.
- Faceted baffle for reduced high frequency diffraction.
- Inclined baffle for correct time alignment of drivers (allowing for simpler cross-over design).
- Wedge shaped inner rear walls behind midwoofer for reduced direct reflections.
- Internal bracing to reduce and distribute cabinet vibrations and hence lower sound coloration.
- Dual ports for distribution of unwanted pipe resonances.
- Inclined inner bottom for reduction of standing waves.
- Solid single-wiring binding posts.

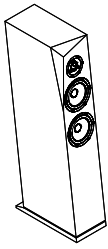

Frequency Response

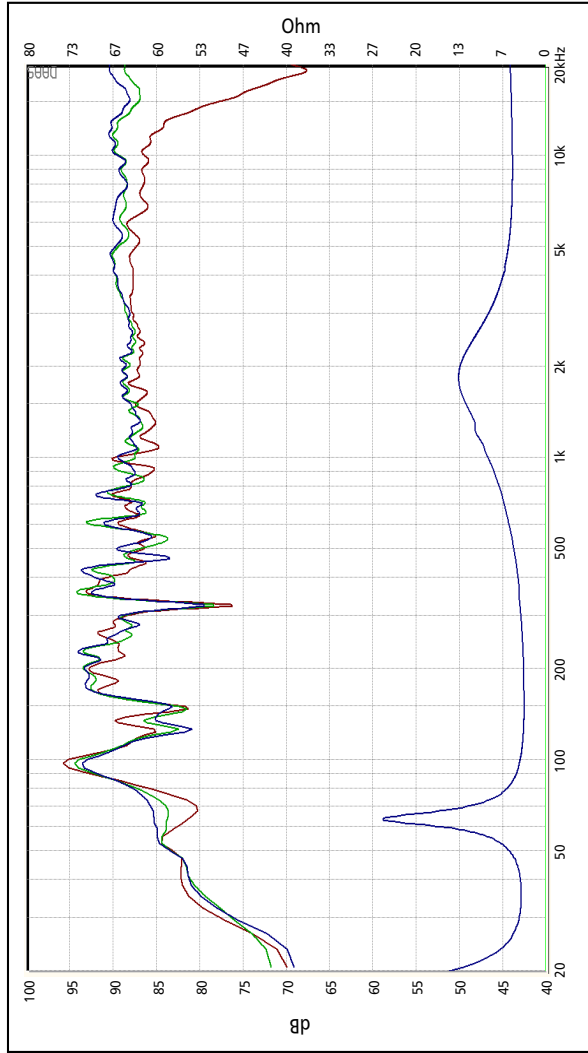

Response Curve :
— (Blue) : on axis
— (Green) : 15° off-axis
— (Red) : 30° off-axis

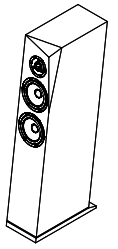

Mechanical Drawing (dimensions in mm)

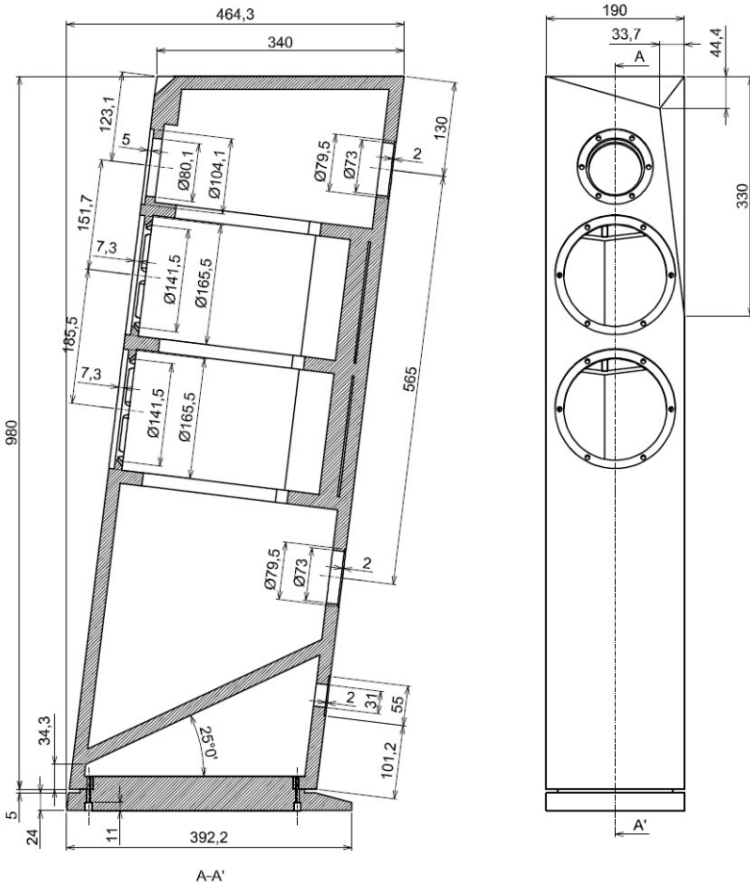

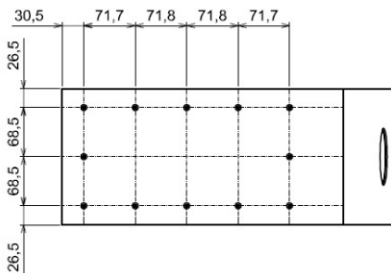
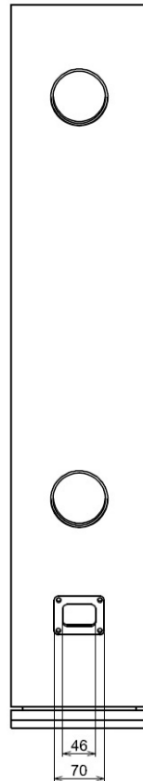
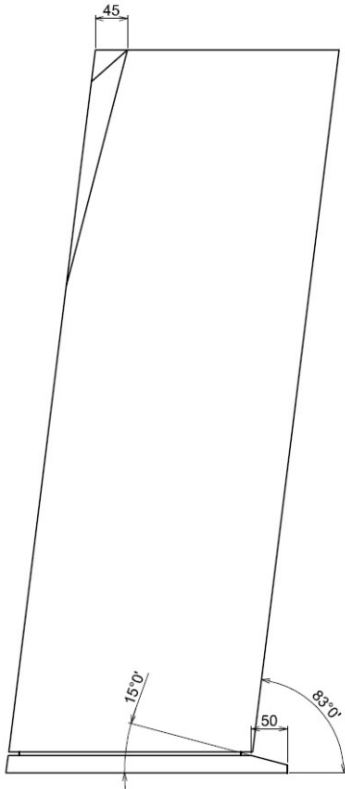
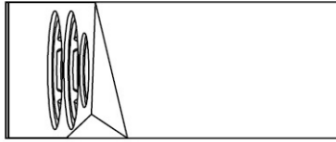
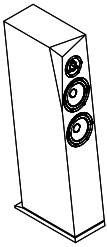

RINJANI - EXPLODED VIEW

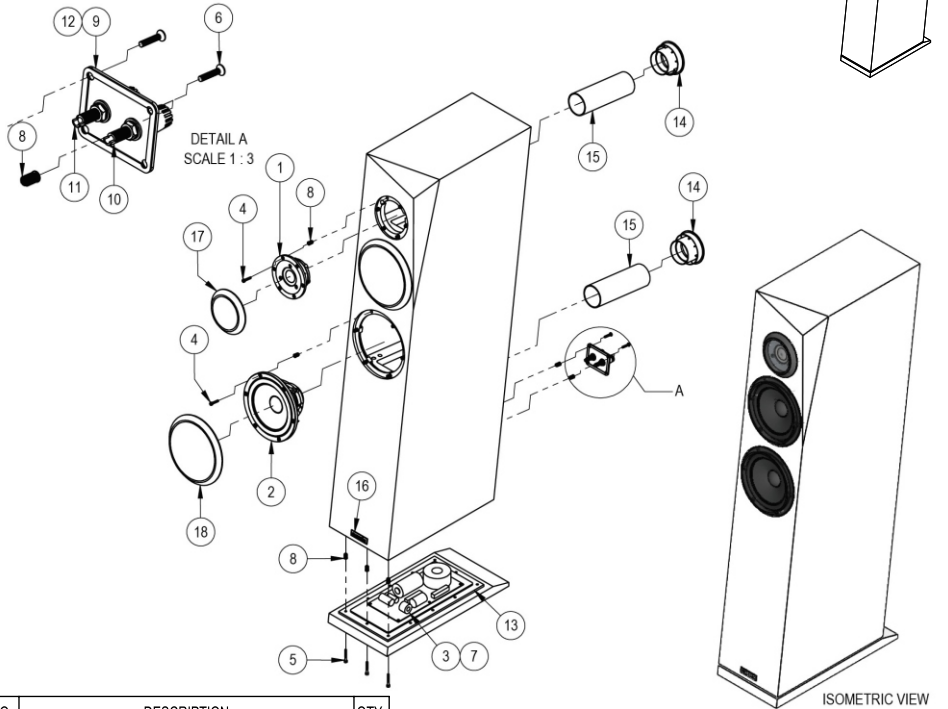

NO.	DESCRIPTION	QTY.
1	SATORI TW29R / TW29R-B (Sold Separately)	1
2	6½" SATORI MW16P-8 / MW16PNW-8 (Sold Separately)	2
3	Rinjani Crossover Kit (Sold Separately)	1
4	Hex Socket Head Screw M4x20mm (For driver)	18
5	Hex Socket Head Screw M4x30mm (For pedestal)	12
6	Hex Socket Flat Head Screw M4x20mm (For terminal plate)	4
7	Wood Screw 4x16mm (From crossover kit)	6
8	Insert Nut M4 (Installed)	34
9	Stainless Steel Terminal Panel	1
10	Binding Post (-) (Black)	1
11	Binding Post (+) (Red)	1
12	Seal Gasket (For terminal plate)	1
13	Seal Gasket (For pedestal)	1
14	Port flare Ø50mm (Installed on cabinet)	2
15	Paper tube Ø50x160mm (Installed on cabinet)	2
16	Name Plate	1
17	Satori TW29 Magnetic Grille	1
18	Satori MW16 Magnetic Grille	2
19	Damping Material (See cut pattern)	1

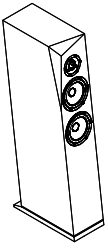

Damping Material Cut Pattern (dimensions in mm)

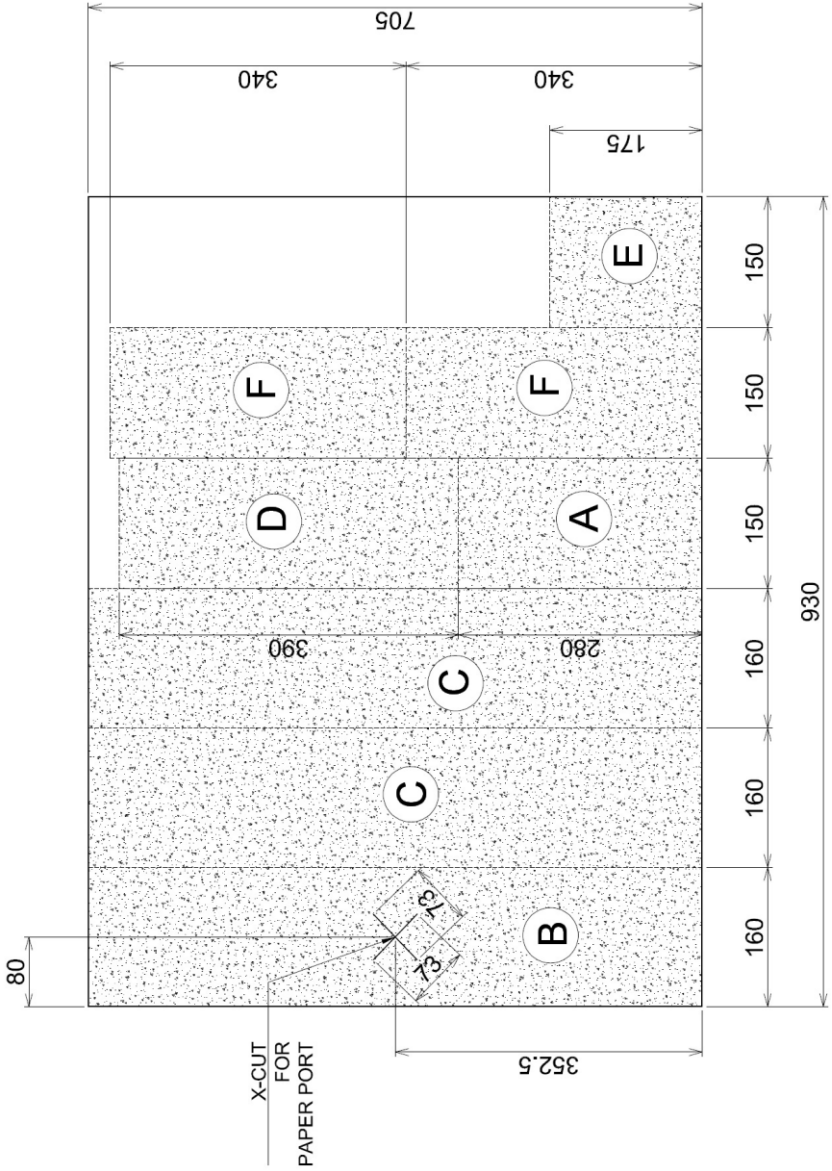

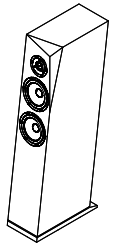

Damping Material Position (dimensions in mm)

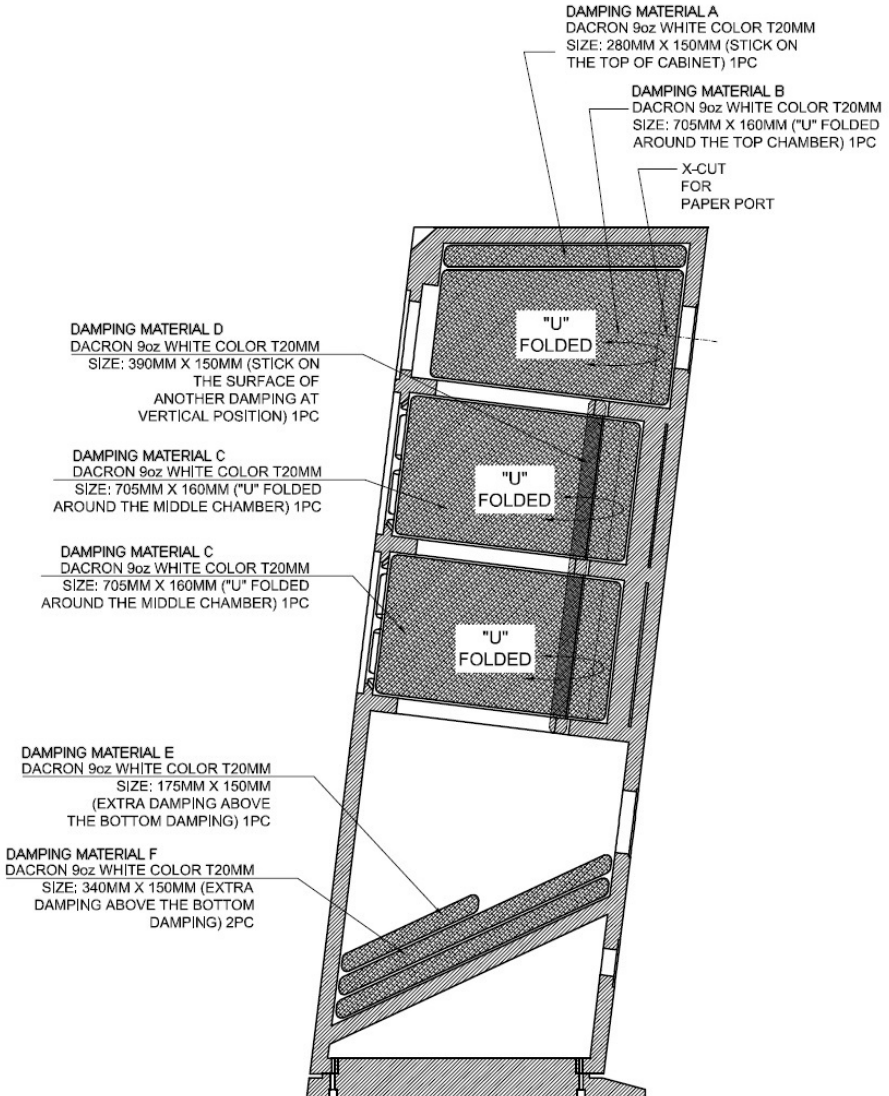

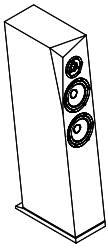

Crossover Schematic (Rinjani)

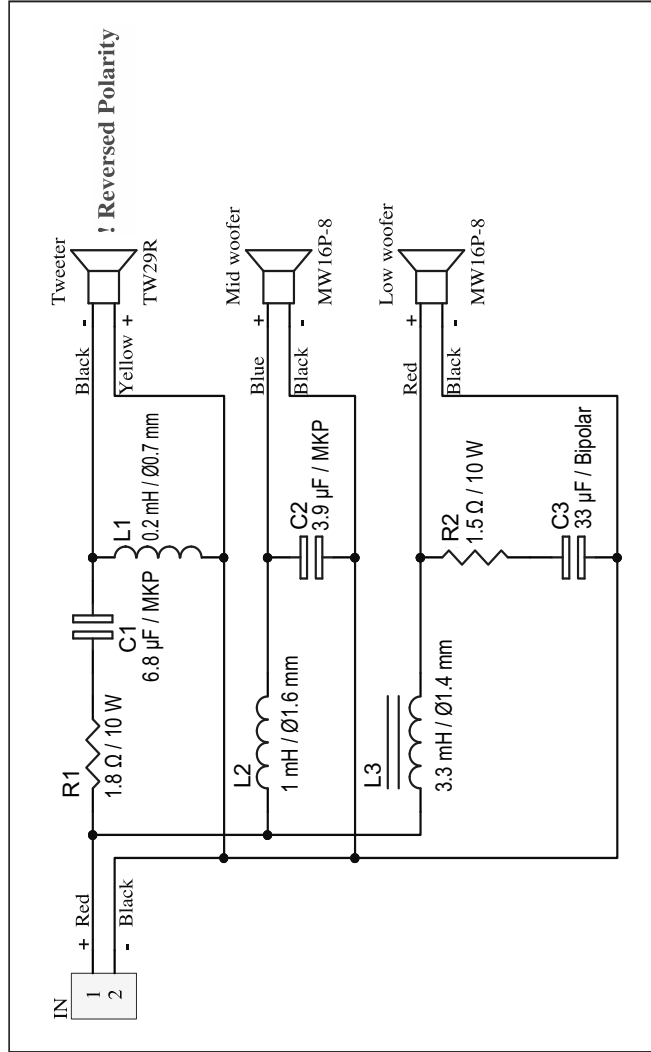

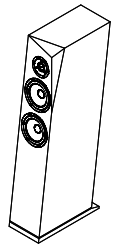

Parts List (each cabinet):

- High frequency driver SATORI TW29R / TW29R-B (sold separately).....	1 pc
- Low frequency drivers 6.5" SATORI MW16P-8 / MW16PNW-8 (sold separately) ..	2 pcs
- Rinjani crossover kit (sold separately)	1 pc
- Hex socket screw M4 x 20mm (for drivers).....	18 pcs
- Hex socket screw M4 x 30mm (for pedestal)	12 pcs
- Countersunk screw M4 x 20mm (for terminal plate)	4 pcs
- Wood screw 4 x 16 mm for crossover (from crossover kit)	6 pcs
- Insert nut M4 (Installed)	34 pcs
- Stainless Terminal plate	1 pc
- Binding post	1 pair
- Seal gasket (for terminal plate)	1 pc
- Seal gasket (for pedestal, installed on cabinet)	1 pc
- Port flare (installed on cabinet)	2 pcs
- Port paper tube (installed on cabinet)	2 pcs
- Damping	1 pc
- Name plate	1pc
- Tweeter grille	1 pc
- Woofer grille	2 pcs

Tools Needed:

- Hex key 3mm size (for driver screw).
- Hex key 2.5mm size (for terminal plate screw).
- Philips screwdriver no. 2 (for crossover screw).
- Hot melt glue gun(for attaching the damping and sealing the wire holes).

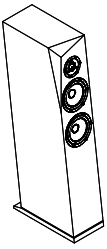

Assembly Instructions:

1. Unpack the cabinet from the packaging and take out the raw damping material from inside the cabinet.



2. Cut the raw damping material to 8 pieces of damping according to the cutting diagram.

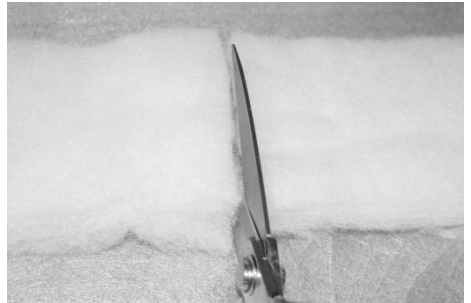

3. Place each damping piece into the cabinet according to the position diagram. Add a bit of glue if needed to hold the damping in place.



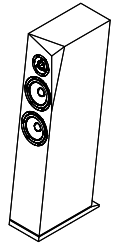

4. Detach the pedestal by removing the four screws in each corner.

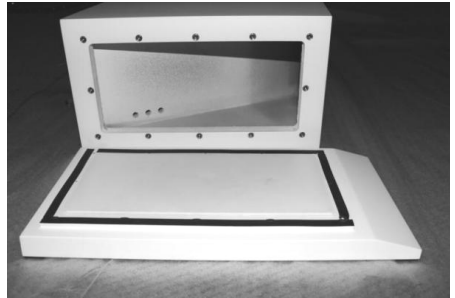

5. Place the crossover on top of the pedestal, with the orientation of the input cable towards the rear terminals and the speaker wires towards the front panel.

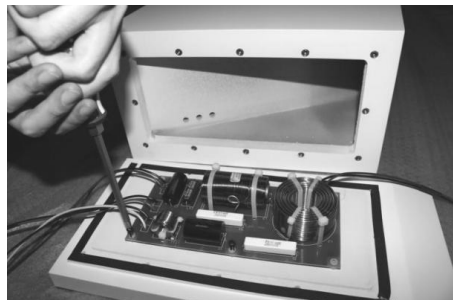

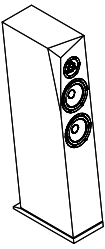

6. Pass the three pairs of speaker wires through each hole in the bottom panel of the cabinet.



7. Seal all the cable holes with hot melt glue.

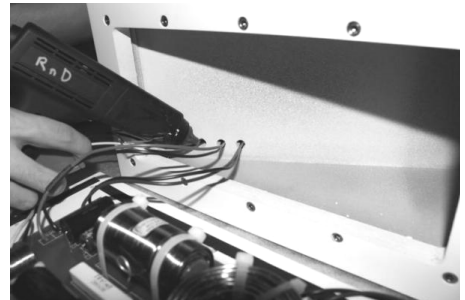

8. Pass the input cables through the terminal hole on the rear of the cabinet, then connect to the binding posts.



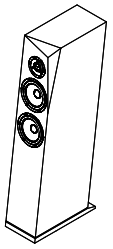

9. Mount the terminal panel into the terminal hole at the rear.



10. Mount the pedestal to the cabinet using all 12 screws.



11. Pull the three pairs of cables through the holes in each cabinet bracing.



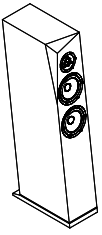

12. Hook up the cables to the woofers and tweeter terminals.



13. Mount the drivers to the cabinet and carefully tighten the screws.



14. Repeat the steps for the other speaker and you have completed your SB ACOUSTICS Rinjani speakers. Time to listen!



Find Us On



www.sbacoustics.com

Rev.0: (07.06.21)