

BIACOUSTICS

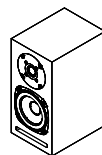

Micro-C / Micro | User Manual



	Micro-C	Micro
Technical Specifications:		
Frequency range	68 - 28000 Hz +/-3 dB	70-28000 Hz +/-3 dB
Sensitivity (2.83V / 1m)	84.5 dB	84.5 dB
Nominal impedance	4Ω	4Ω
Max SPL	100 dB	100 dB
Recommended amplifier	25 - 100 W	25 - 100 W
Cross-over frequency	4000 Hz	4000 Hz
Speaker type	2-way Bookshelf	2-way Bookshelf
Enclosure type	Bass reflex	Bass reflex
Port tuning frequency	49 Hz	49 Hz
Drive Units:		
High frequency driver	SB19ST-C000-4	SB19ST-C000-4
Low frequency drivers	4in SB12CAC25-4	4" SB12PAC25-4
Cabinet:		
	15mm MDF	15mm MDF
Dimensions (H x W x D)	262 x 132 x 170 mm 10.3 x 5.2 x 6.7 inch	260 x 130 x 170 mm 10.2 x 5.1 x 6.7 inch
Net Weight (pair):		
Cabinet only	4.3 kg / 9.48 lb	4.2 kg / 9.26 lb
Full assembly	7.8 kg / 17.2 lb	7.4 kg / 16.32 lb
Special Features:		

- High performance compact design.
- Optimized drivers.
- Simple high quality cross-over network.
- Front firing integrated port.
- Versatile placement.
- Solid single wiring binding posts.



Frequency Response (Micro-C)

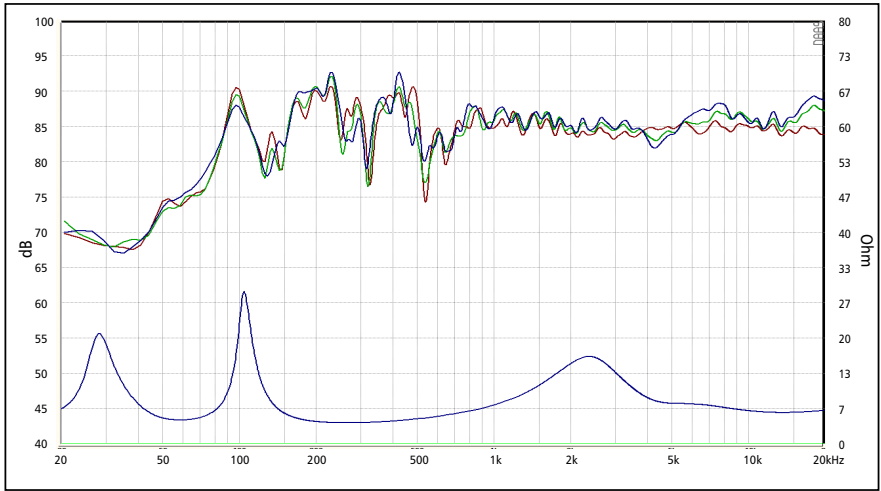

Frequency Response (Micro)

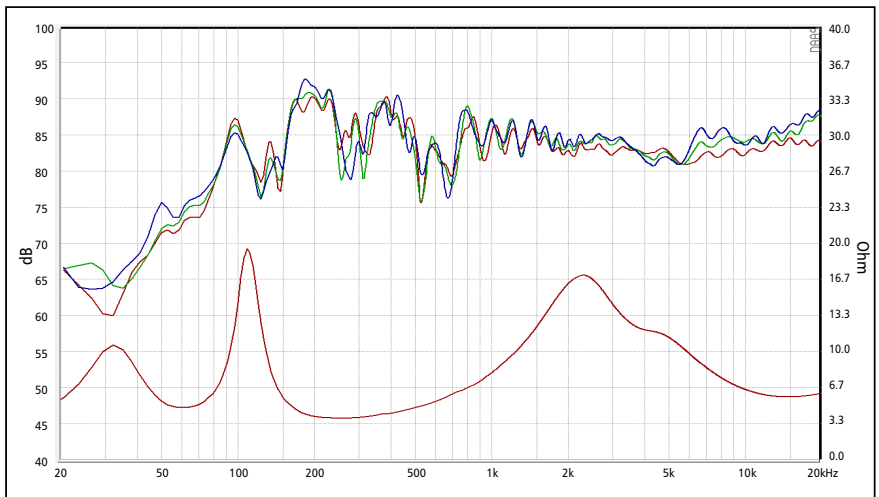

Response Curve :
— (Blue) : on axis — (Green) : 15° off-axis — (Red) : 30° off-axis

Measured on-axis, 15° and 30° off-axis at 1 m in an ordinary room. Lower frequency dips and peaks are caused by room modes/reflections.

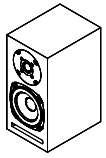

Mechanical Drawing (dimensions in mm) / Micro-C

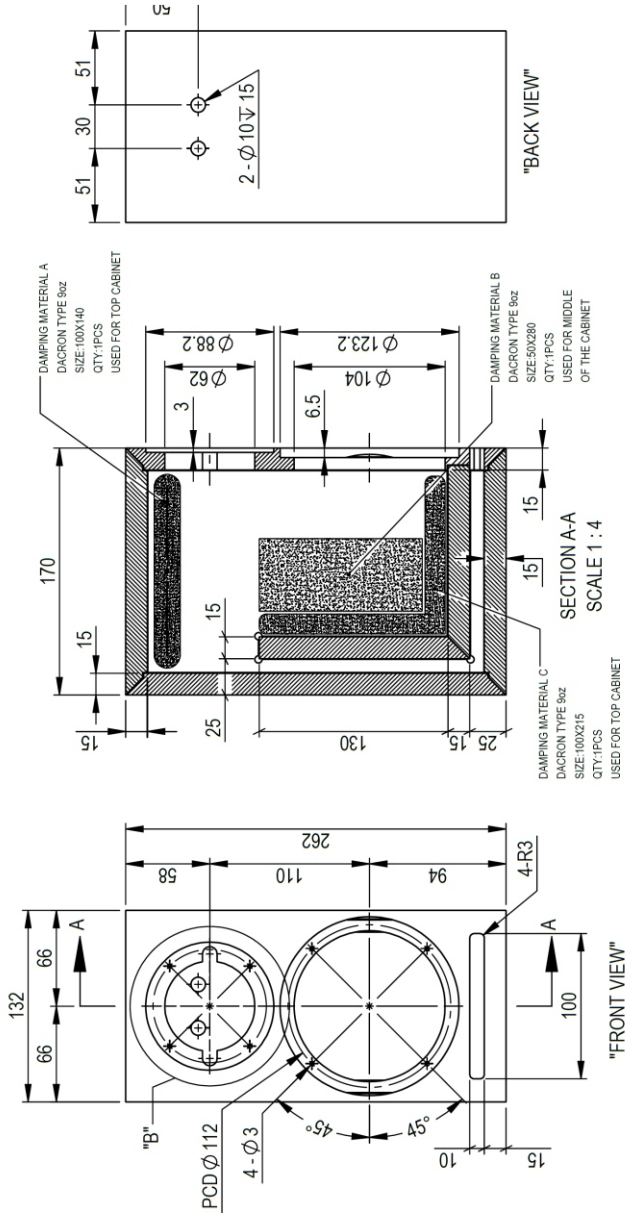

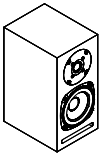

Mechanical Drawing (dimensions in mm) / Micro

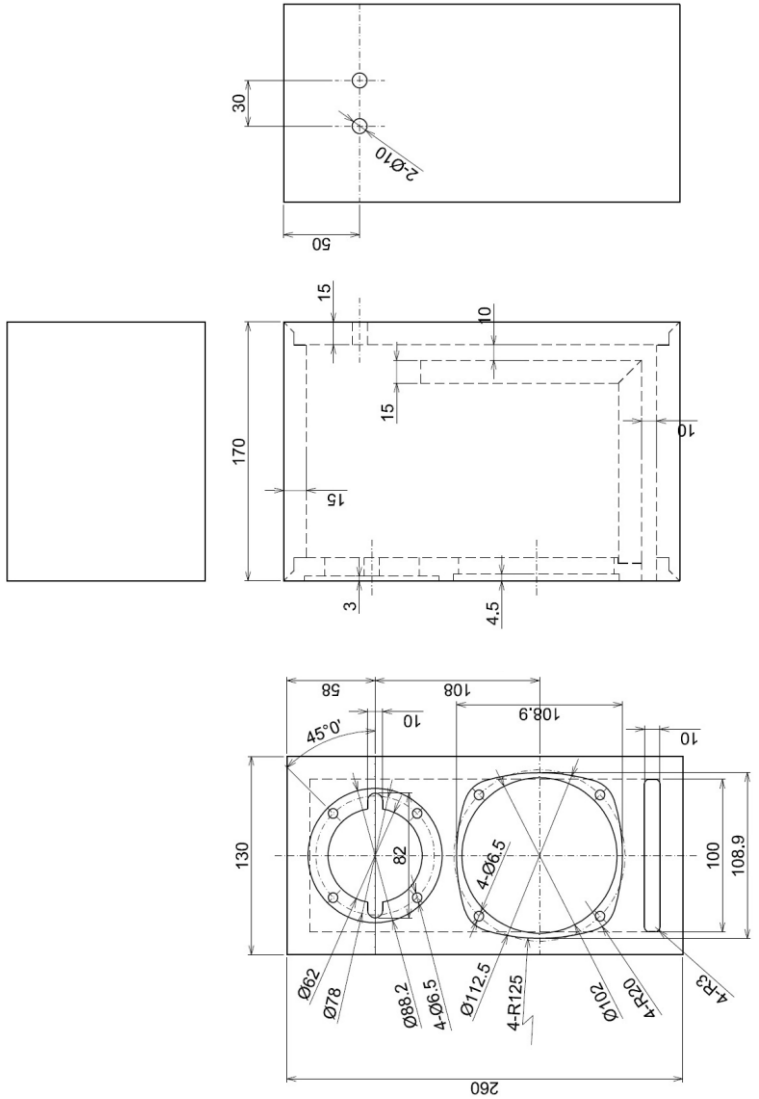

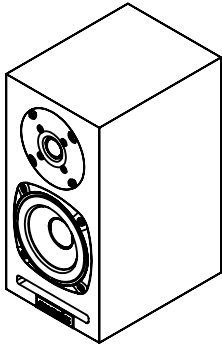
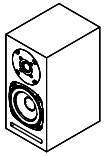

ISOMETRIC VIEW (MICRO)

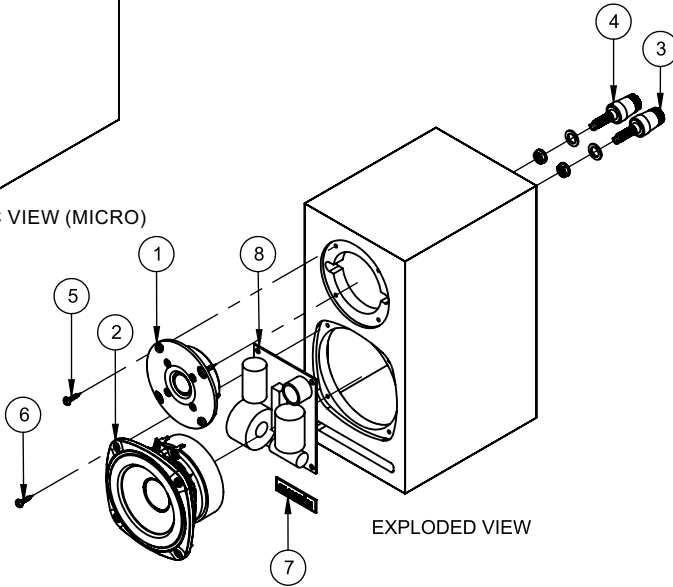

EXPLODED VIEW

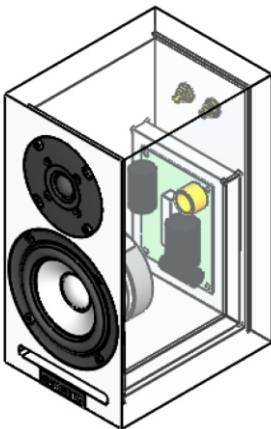

ISOMETRIC VIEW (MICRO-C)

NO.	PART LIST	QTY.
1	SB19ST-C000-4 (Sold separately)	1
2	4in SB12PAC25-4 Or 4in SB12CAC25-4 (Sold separately)	1
3	Binding Post (-) (Black)	1
4	Binding Post (+) (Red)	1
5	Wood Screw 3½x20mm	4
6	Wood Screw 4x20mm	4
7	Name Plate	1
8	Cross Over (Sold separately)	1
9	Damping Material (See cut pattern)	1



Damping Material Cutting Pattern (dimensions in mm)

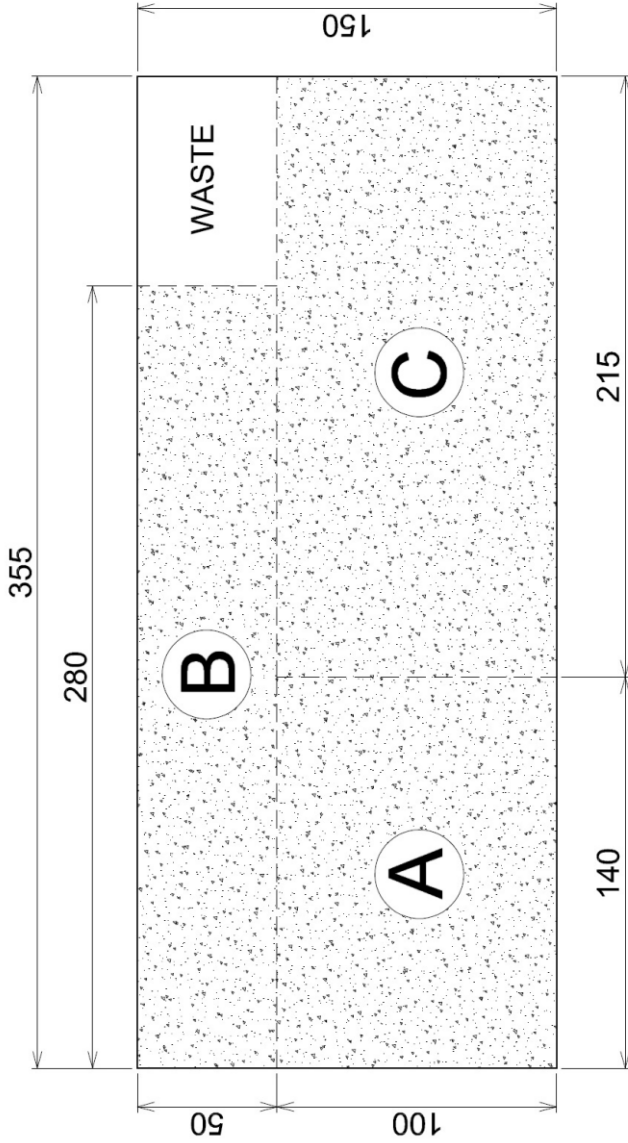

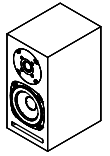

Damping Material Position (dimensions in mm)

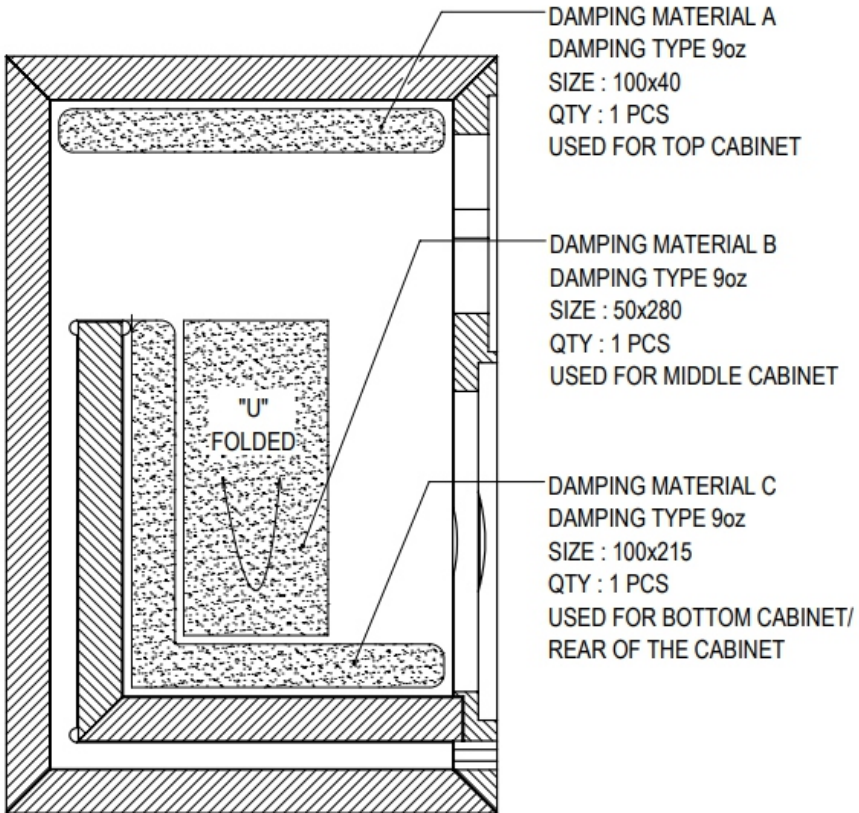

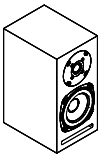

Crossover Schematic

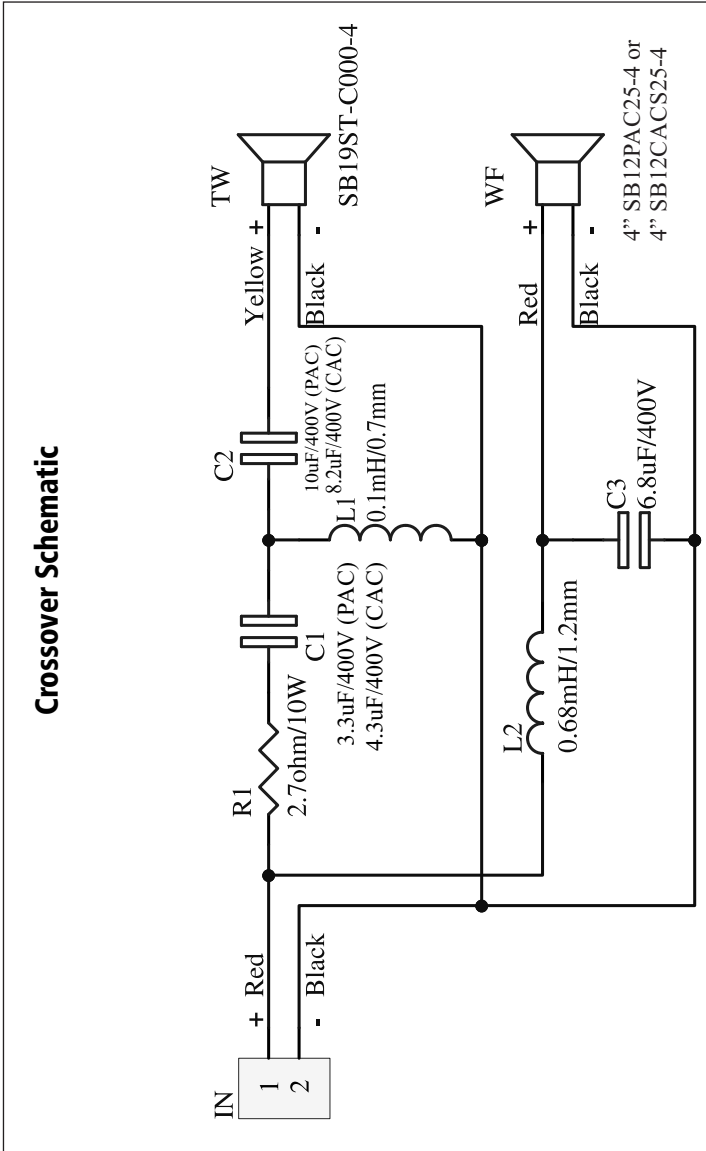

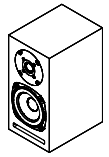

Part List (each cabinet):

- High frequency driver SB19ST-C000-4 (sold separately)	1 pc
- Low frequency drivers 4" SB12PAC25-4 or 4" SB12CAC25-4 (sold separately) ..	1 pc
- Micro crossover kit (sold separately).....	1 pc
- Wood Screw 3.5 x 20 mm for tweeter	4 pcs
- Wood Screw 4 x 20 mm for woofer	4 pcs
- Wood Screw 4 x 16 mm for crossover (from crossover kit).....	4 pcs
- Binding post terminal	1 pair
- Damping	1 pc
- Name plate	1 pc

Tools Needed:

- No. 2 Philips screwdriver (for drivers and crossover screw).
- 11 mm hex socket (for tightening binding post nut).
- Multipurpose glue.
(for attaching the damping and sealing the terminal hole).

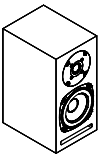

Assembly Instructions:

1. Take out the cabinet from the packaging and take out the raw damping material from the cabinet.

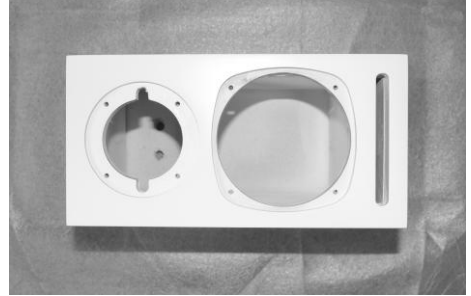

2. Unscrew the binding post nut then attach both binding post terminals on the rear of the cabinet.

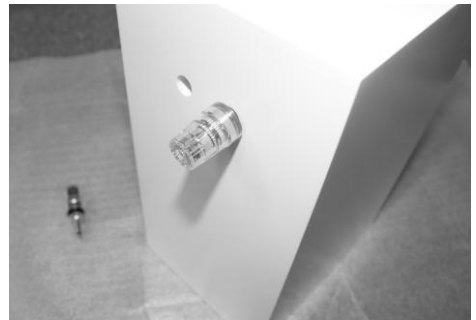

3. Fastern each terminal from the inside of the cabinet using the terminal nuts.



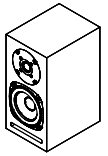

4. Tighten the nut using 11 mm hex socket head. Put some glue around the nut to seal the cabinet.



5. Place the crossover on the rear panel inside the cabinet.

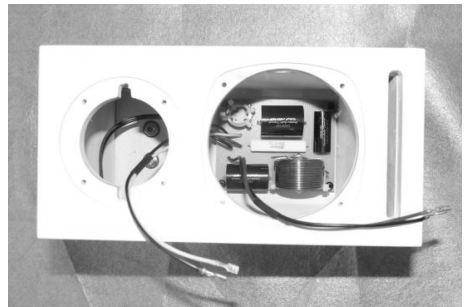

6. Secure the crossover to the cabinet with the four screws. One screw in each corner.





7. Connect both crossover input cables to the binding post terminals.

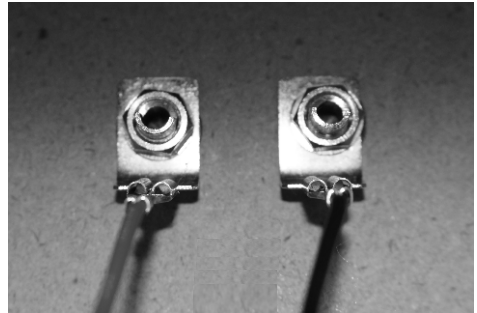

8. Cut the raw damping material according to the cutting diagram.

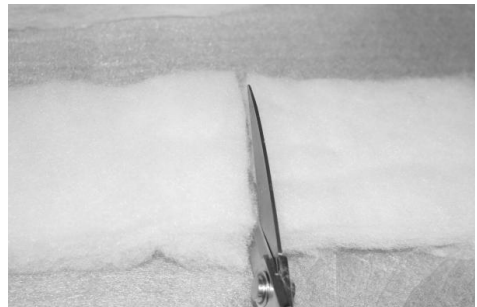

9. Place each part of the damping material the cabinet according to damping position diagram. Add a bit of glue if needed to hold the damping material in place.



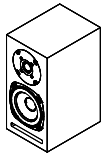

10. Attach the tweeter cables from the crossover to the tweeter terminals, then place the tweeter into the tweeter cutout on the cabinet, align the screw holes to the cabinet screw holes.

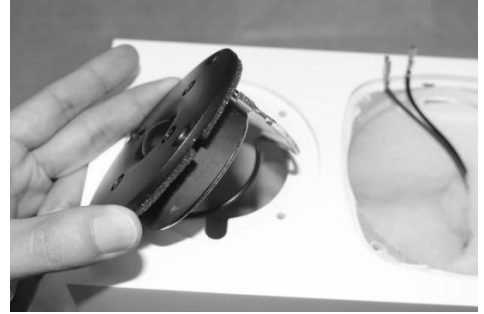

11. Attach the woofer cables from the crossover to the woofer terminals, then place the woofer into the woofer cutout on the cabinet, align the chassis screw holes to the cabinet screw holes.



12. Fasten the tweeter and woofer screws to the cabinet.

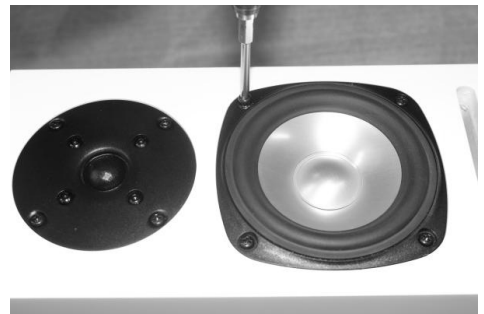

13. Repeat the steps for the second speaker and you have finished the assembly process.
Happy listening!.

Find Us On



www.sbacoustics.com