

L16RN3 is a High Fidelity woofer with an injection moulded metal chassis, intended for bass reflex and closed box designs.

Optimized cone design combined with the stiff and light weight aluminium gives a high break-up point to allow for easier crossover design and wider bandwidth than common aluminium cones.

Titanium voice coil former with a very long copper coil winding and a bumped back-plate for excellent force transfer, transient sound reproduction and large linear excursion.

A heavy copper ring below the T-shaped pole piece reduces non linear and modulation distortion.

Extremely stiff and stable injection moulded metal basket, keeps the critical components in perfect alignment. Large windows in the basket both above and below the spider reduce sound reflection, air flow noise and cavity resonance to a minimum.

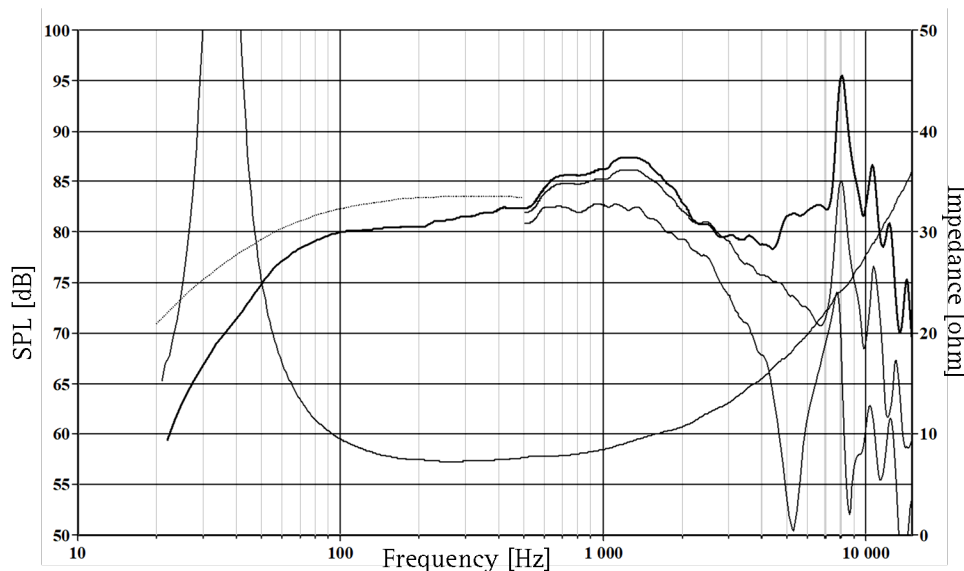

The frequency responses above show measured free field sound pressure in 0, 30, and 60 degrees angle using a 10L closed box. Input 2.83 VRMS, microphone distance 0.5m, normalized to SPL 1m. The dotted line is a calculated response in infinite baffle based on the parameters given for this specific driver. The impedance is measured in free air without baffle using a 2V sine signal.

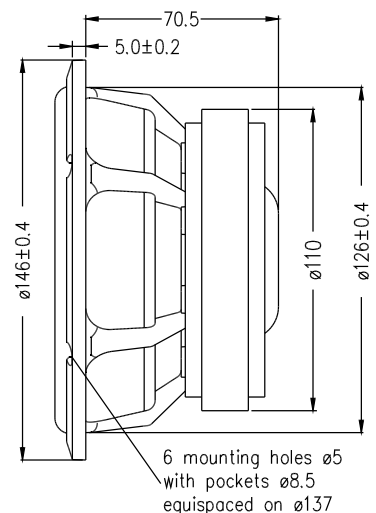

Nominal Impedance	8 Ohms	Voice Coil Resistance	6.4 Ohms
Recommended Frequency Range	20 - 3000 Hz	Voice Coil Inductance	0.6 mH
Short Term Power Handling *	300 W	Force Factor	8.7 N/A
Long Term Power Handling *	200 W	Free Air Resonance	32 Hz
Characteristic Sensitivity (2,83V, 1m)	84 dB	Moving Mass	20.8 g
Voice Coil Diameter	39 mm	Suspension Compliance	1.2 mm/N
Voice Coil Height	20 mm	Suspension Mechanical Resistance	0.76 Ns/m
Air Gap Height	6 mm	Effective Piston Area	104 cm ²
Linear Coil Travel (p-p)	14 mm	VAS	18 Litres
Maximum Coil Travel (p-p)	22 mm	QMS	5.48
Magnetic Gap Flux Density	1.1 T	QES	0.35
Magnet Weight	0.64 kg	QTS	0.33
Total Weight	1.80 kg		