

S|ACOUSTICS

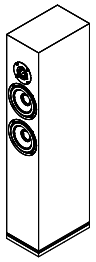

Arya | User Manual



Technical Specifications:

Frequency range	: 44-28000 Hz +/-3 dB
Sensitivity (2.83V / 1m)	: 87.5 dB
Nominal impedance	: 4Ω
Max SPL	: 107 dB
Recommended amplifier	: 50-200W
Cross-over frequency	: 3000 Hz
Speaker type	: 2½-way Floor Stand
Enclosure type	: Bass reflex
Port tuning frequency	: 41 Hz

Drive Units:

- High frequency driver : SB29RDAC-C000-4
- Low frequency drivers : 2 x 6" SB17MFC35-8

Cabinet:

18 mm MDF

Dimensions (H x W x D) : 1076 x 195 x 310 mm / 42.36 x 7.68 x 12.2 inch

Net Weight (pair):

- Cabinet only : 18.73 kg / 41.29 lb
- Full assembly : 22.54 kg / 49.69 lb

Special Features:

- High quality drivers.
- Diffraction optimized cabinet proportions.
- Internal bracing to reduce and distribute cabinet vibrations.
- Dual vents and slanted internal bottom plate for reduction of standing wave resonances.

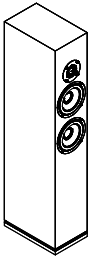

Frequency Response

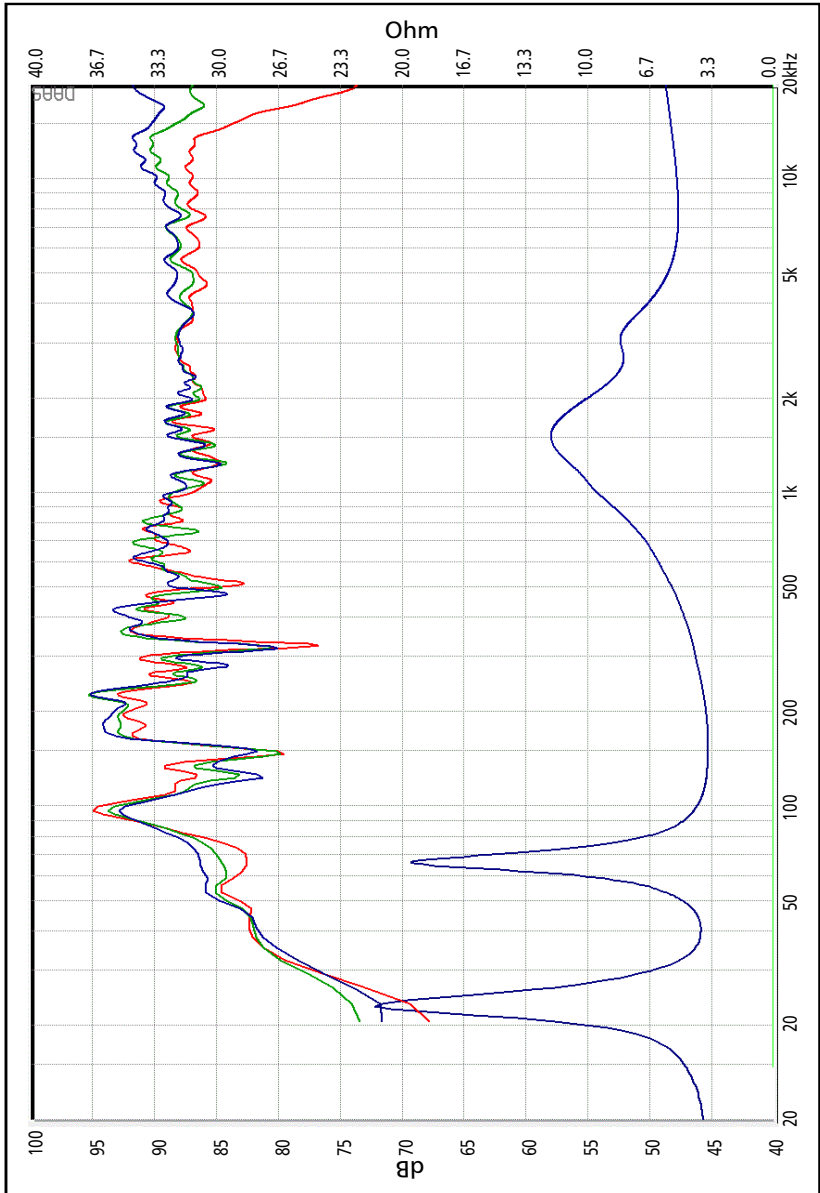

Response Curve :
— (Blue) : on axis
— (Green) : 15° off-axis
— (Red) : 30° off-axis

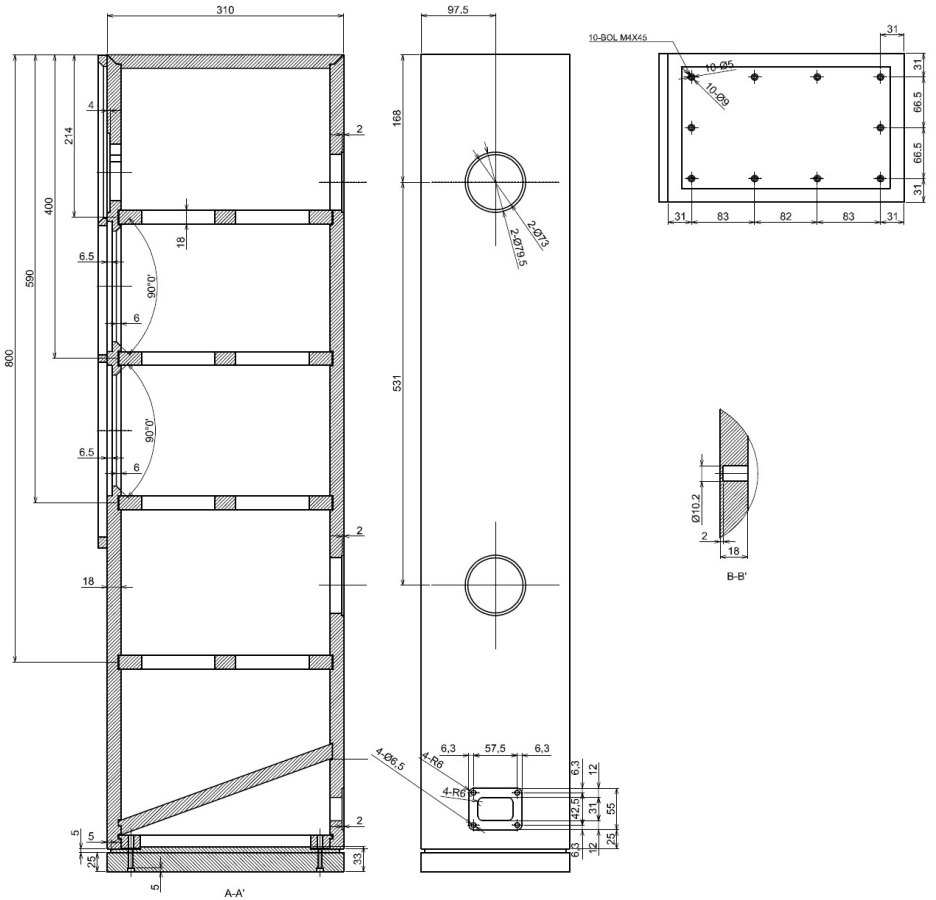
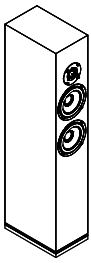

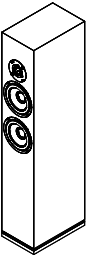

ARYA - EXPLODED VIEW

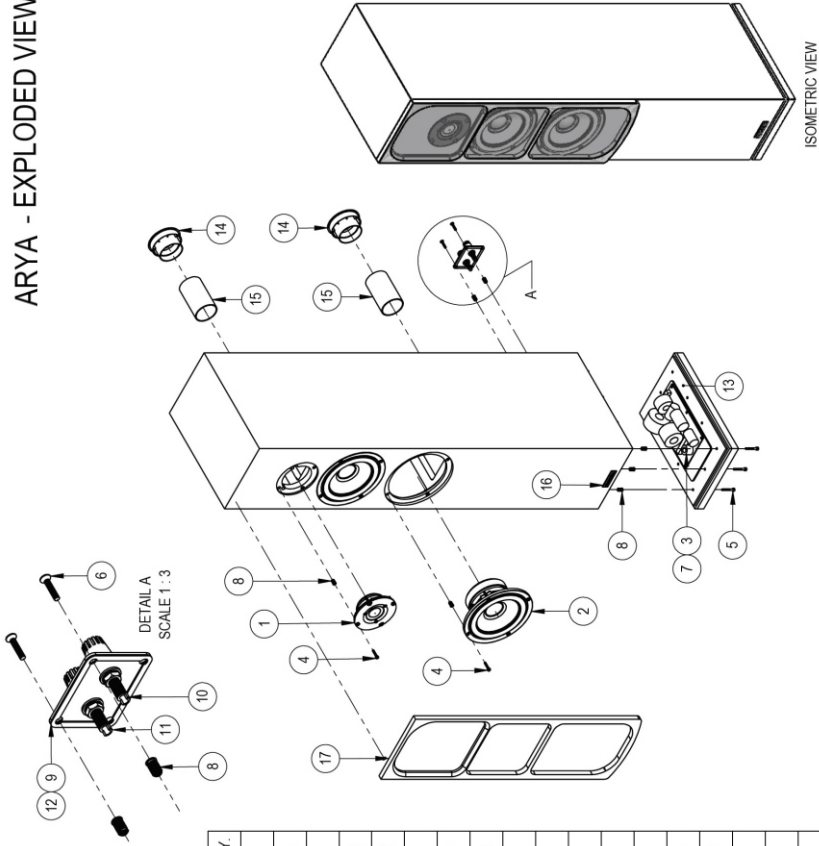

NO.	PART LIST	QTY.
1	SB29RDAC-C000-4 (Sold separately)	1
2	6" SB17MFC35-8 (Sold separately)	2
3	Arya Kit Crossover (Sold separately)	1
4	Hex Socket Screw 4x20mm (For driver)	12
5	Hex Socket Screw 4x30mm (For pedestal)	10
6	Countersunk Screw 4X20mm (For terminal plate)	4
7	Wood Screw 4x16mm (From kit crossover)	6
8	Insert Nut M4 (Installed)	26
9	Stainless Steel Terminal Panel	1
10	Binding Post (-) (Black)	1
11	Binding Post (+) (Red)	1
12	Seal Gasket (For terminal plate)	1
13	Seal Gasket (For pedestal)	1
14	Port tube d:50mm (Installed on cabinet)	2
15	Paper tube d:50mm L:90mm (Installed on cabinet)	2
16	Name Plate	1
17	Speaker Grille	1
18	Damping Material (See cut pattern)	1

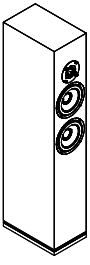

Damping Material Cut Pattern (dimensions in mm)

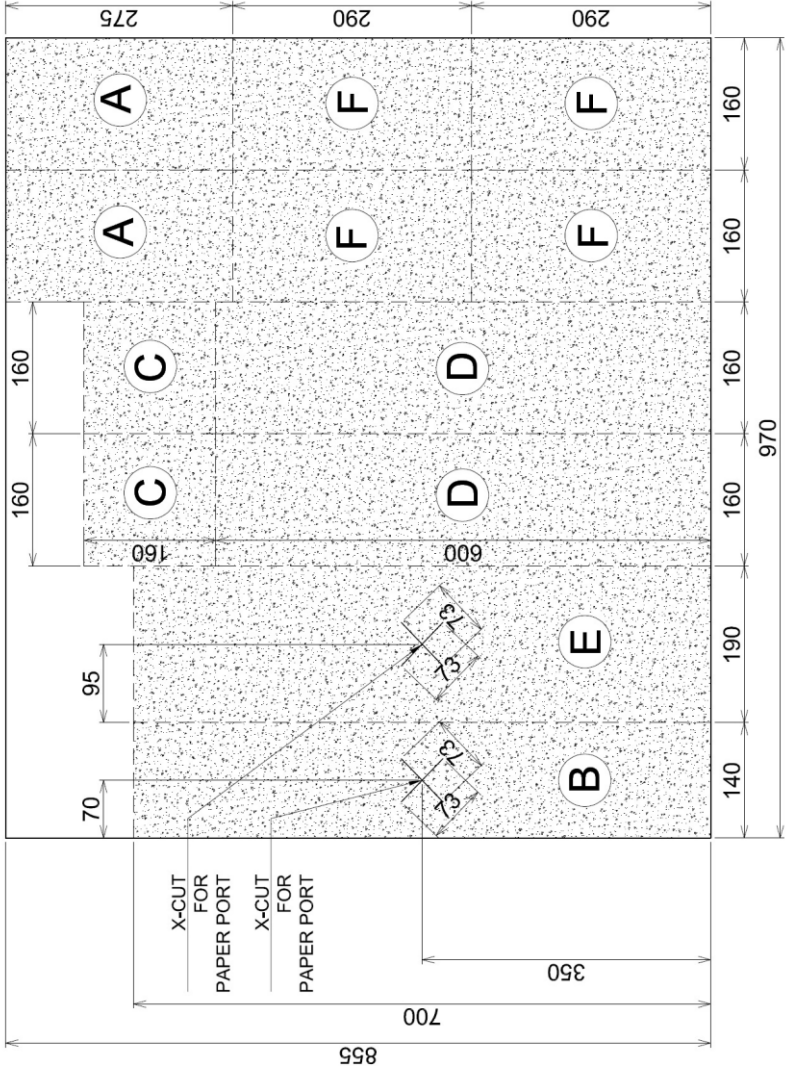

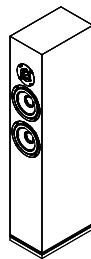

Damping Material Position (dimensions in mm)

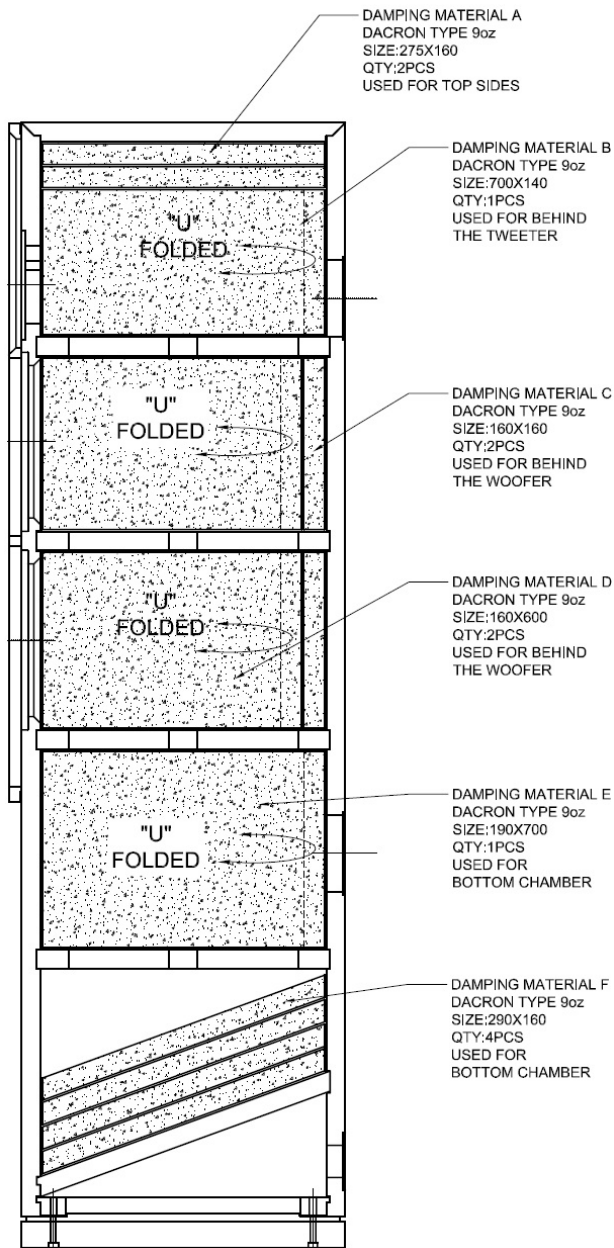

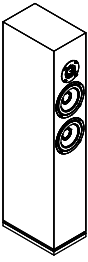

Crossover Schematic

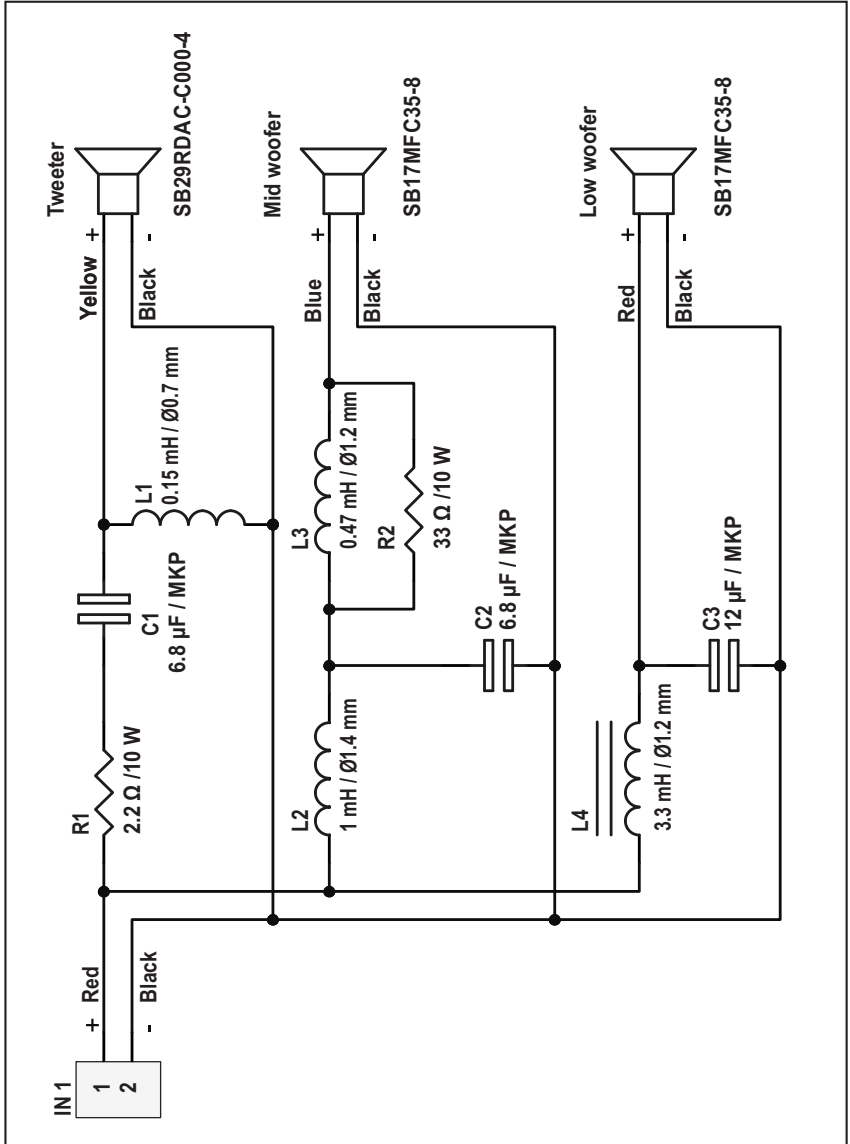

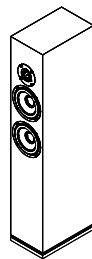

Part List (each cabinet):

- High frequency driver SB29RDAC-C000-4 (sold separately).....	1 pc
- Low frequency driver 6" SB17MFC35-8 (sold separately).....	2 pcs
- Arya crossover kit (sold separately)	1 pc
- Hex socket screw M4 x 20mm (for drivers).....	12 pcs
- Hex socket screw M4 x 30mm (for pedestal)	10 pcs
- Countersunk screw M4 x 20mm (for terminal plate)	4 pcs
- Wood screw 4 x 16 mm for crossover (from crossover kit)	6 pcs
- Insert nut M4 (Installed on cabinet)	26 pcs
- Stainless Terminal plate	1 pc
- Binding post	1 pair
- Seal gasket (for terminal plate)	1 pc
- Seal gasket (for pedestal, installed on cabinet)	1 pc
- Port flare (installed on cabinet)	2 pcs
- Port paper tube (installed on cabinet)	2 pcs
- Damping	1 pc
- Name plate	1pc
- Speaker grille	1 pc

Tools Needed:

- Hex key 3mm size (for driver and pedestal screw).
- Hex key 2.5mm size (for terminal plate screw).
- Philips screwdriver no. 2 (for crossover screw).
- Multipurpose glue (for attaching the damping and sealing the wire hole).

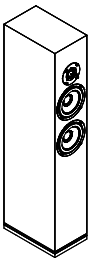

Assembly Instructions:

1. Unpack the cabinet from the packaging and take out the raw damping material from inside the cabinet.



2. Cut the raw damping material to 12 pieces of damping according to the cutting diagram.

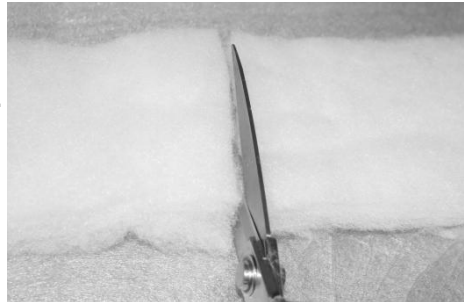

3. Place each damping piece into the cabinet according to the position diagram. Add a bit of glue if needed to hold the damping in place.

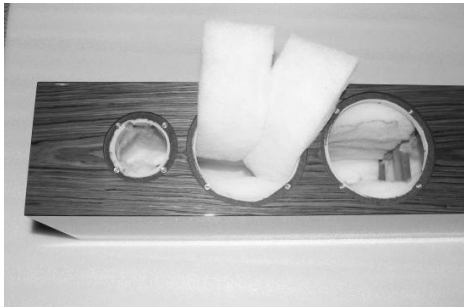

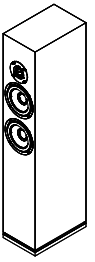

4. Detach the pedestal by removing the four screws in each corner.

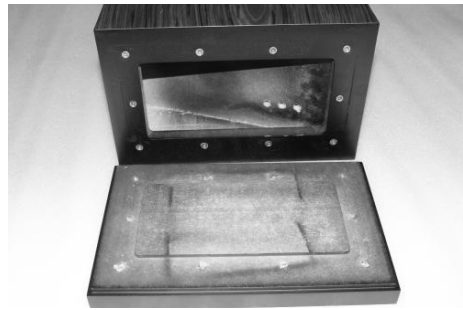

5. Place the crossover on top of the pedestal, with the orientation of the input cable towards the rear terminals and the speaker wires towards the front panel.

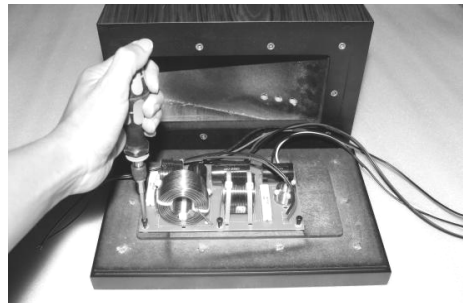

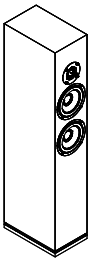

6. Pass the three pairs of speaker wires through each hole in the bottom panel of the cabinet.

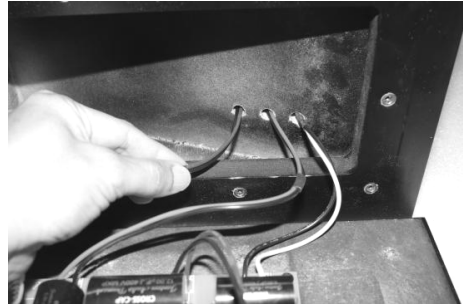

7. Seal all the cable holes with hot melt glue.

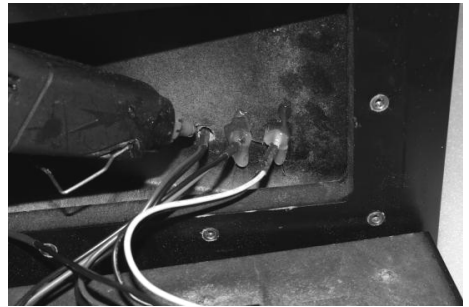

8. Pass the input cable through the terminal hole on the rear of the cabinet, then connect to the binding posts.

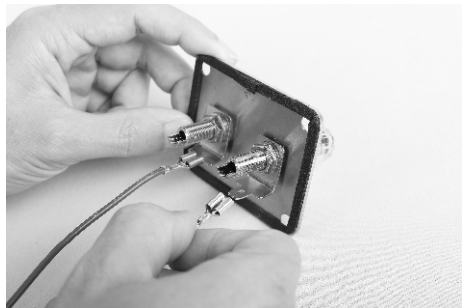

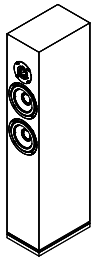

9. Mount the terminal panel into the terminal hole at the rear.



10. Mount the pedestal to the cabinet using all 10 screws.



11. Pull the three pairs of cables through the holes in each cabinet bracing.



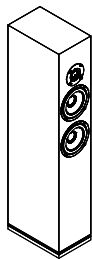

12. Hook up the cables to the woofers and tweeter terminals.



13. Mount the drivers to the cabinet and carefully tighten the screws.



14. Repeat the steps for the other speaker and you have completed your SB ACOUSTICS Arya speakers. Time to listen!.



Find Us On



www.sbacoustics.com