

B|ACOUSTICS

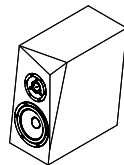

Ara | User Manual

**Technical Specifications:**

Frequency range	:	45-25000 Hz +/-3 dB
Sensitivity (2.83V / 1m)	:	87 dB
Nominal impedance	:	4Ω
Max SPL	:	105 dB
Recommended amplifier	:	40-150 W
Cross-over frequency	:	3000 Hz
Speaker type	:	2-way
Enclosure type	:	Bass reflex
Port tuning frequency	:	36.5 Hz

Drive Units:

- High frequency driver : SATORI TW29R
(29 mm soft ring dome)
- Low frequency drivers : 6½" SATORI MW16P-4
(advanced midwoofer)

Cabinet:

18 mm MDF

Dimensions (H x W x D): 391 x 190 x 388 mm / 15.4 x 7.48 x 15.27 inch

Net Weight (pair):

- Cabinet only : 8.06 kg / 17.77 lb
- Full assembly : 9.6 kg / 21.16 lb

Special Features:

- Advanced high-end drivers.
- Faceted cabinet baffle for reduced high frequency diffraction.
- Inclined baffle for correct time alignment of drivers (allowing for simpler cross-over design).
- Wedge shaped inner rear walls behind midwoofer for reduced direct reflections.
- Internal bracing to reduce and distribute cabinet vibrations and hence lower sound coloration.
- Solid single-wiring binding posts.

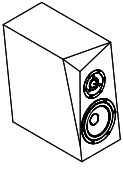

Frequency Response (Ara)

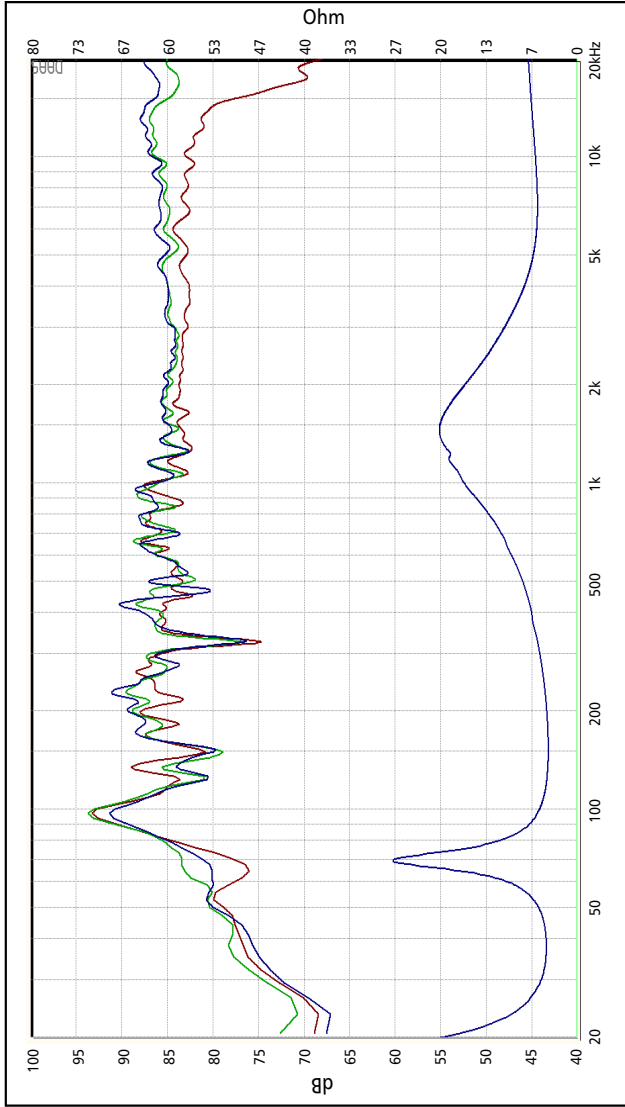

Response Curve :
— (Blue) : on axis
— (Green) : 15° off-axis
— (Red) : 30° off-axis

Measured on-axis, 15° and 30° off-axis at 1 m in an ordinary room. Lower frequency dips and peaks are caused by room modes/reflections.

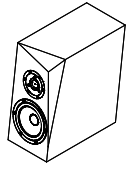

Mechanical Drawing (dimensions in mm)

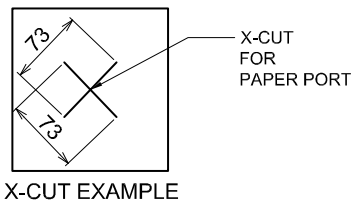
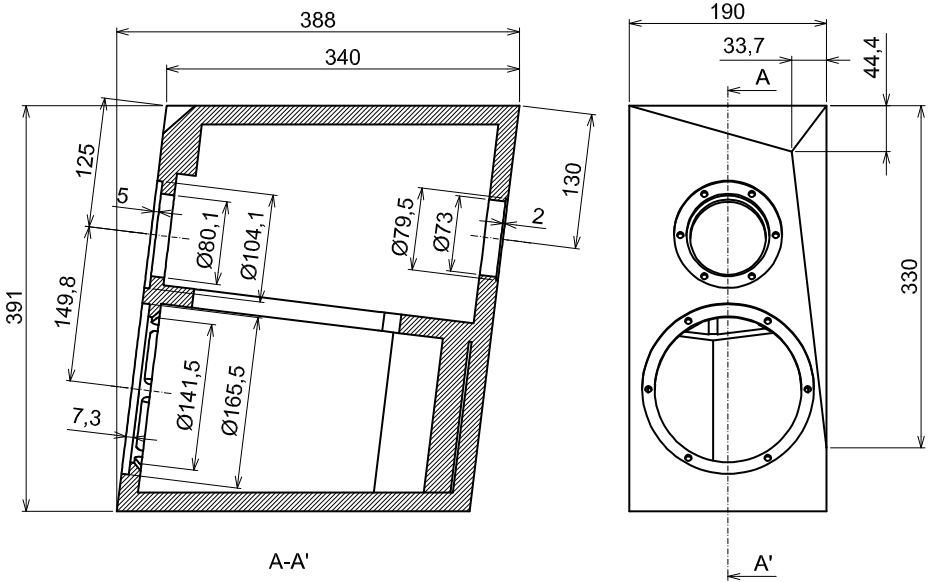

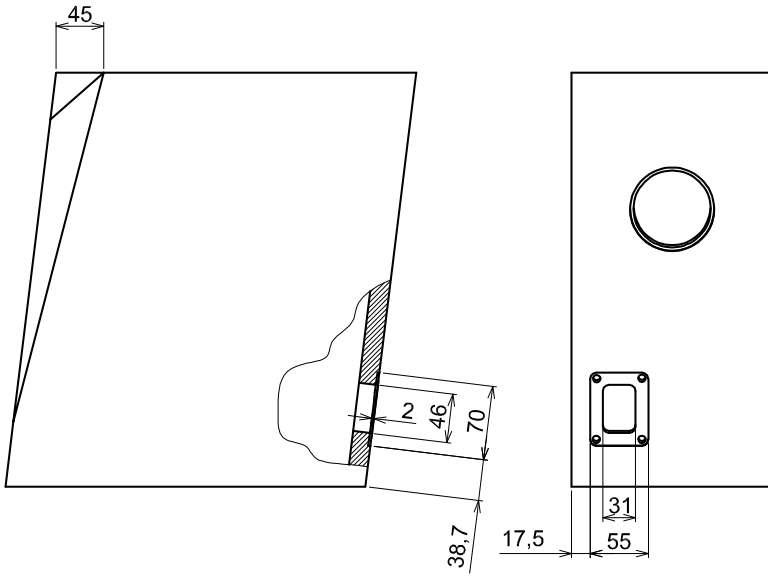
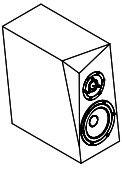

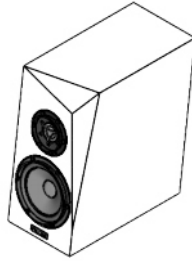
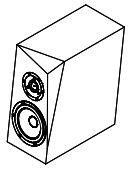

ISOMETRIC VIEW

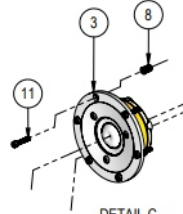
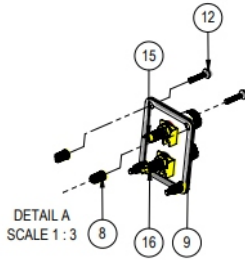
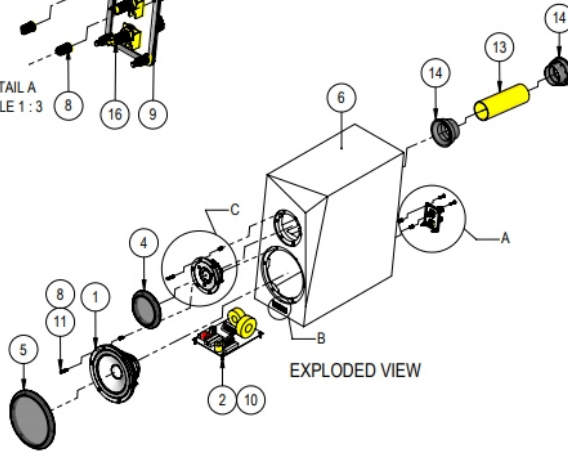
DETAIL B
SCALE 1 : 2DETAIL C
SCALE 1 : 4DETAIL A
SCALE 1 : 3

EXPLODED VIEW

NO.	PART NUMBER	QTY.	NO.	PART NUMBER	QTY.
1	SATORI TW29R (Sold separately)	1	9	Binding Post (-) (Black)	1
2	6½" SATORI MW16P-4 (Sold separately)	1	10	Binding Post (+) (Red)	1
3	Ara Kit Crossover (Sold separately)	1	11	Seal Gasket (For terminal plate)	1
4	Hex Socket Screw 4x20mm (For driver)	12	12	Port flare d:50mm (Installed on cabinet)	2
5	Countersunk Screw 4X20mm (For terminal plate)	4	13	Paper tube d:50mm L:160mm (Installed on cabinet)	1
6	Wood Screw 4x16mm (From kit crossover)	6	14	Name Plate	1
7	Insert Nut M4 (Installed)	16	15	Grille for tweeter	1
8	Stainless Steel Terminal Panel	1	16	Grille for woofer	1
			17	Damping Material (See cut pattern)	1

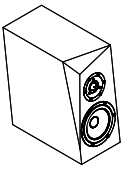

Damping Material Cut Pattern (dimensions in mm)

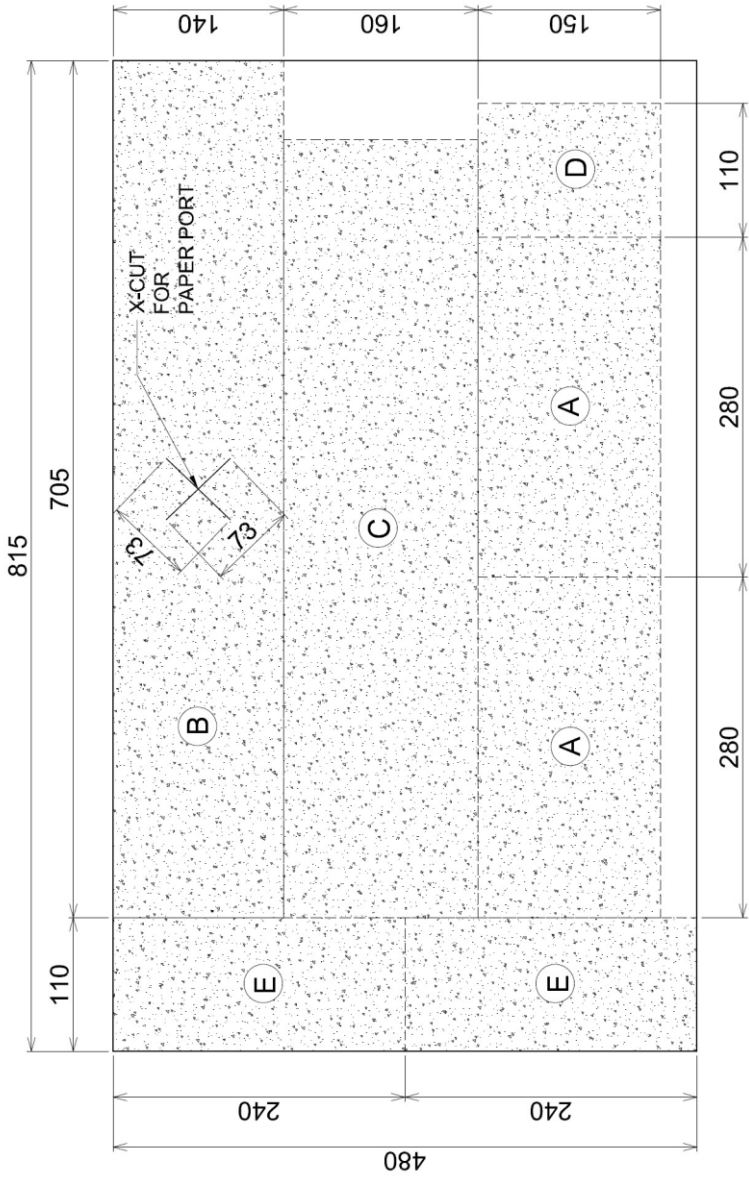

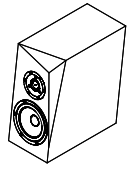

Damping Material Position (dimensions in mm)

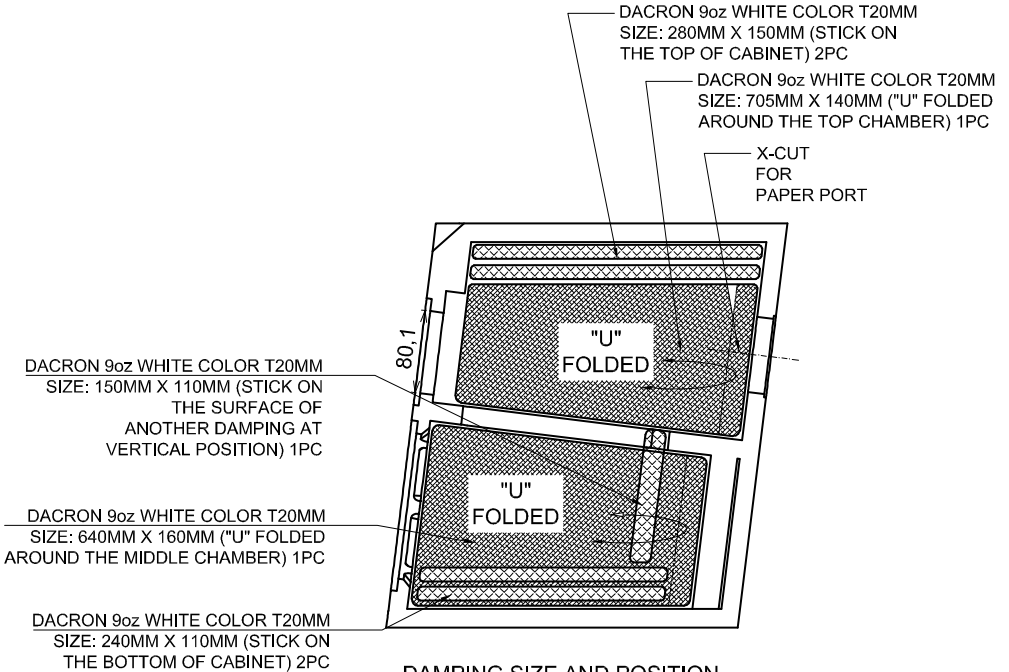

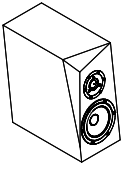

Crossover Schematic Ara

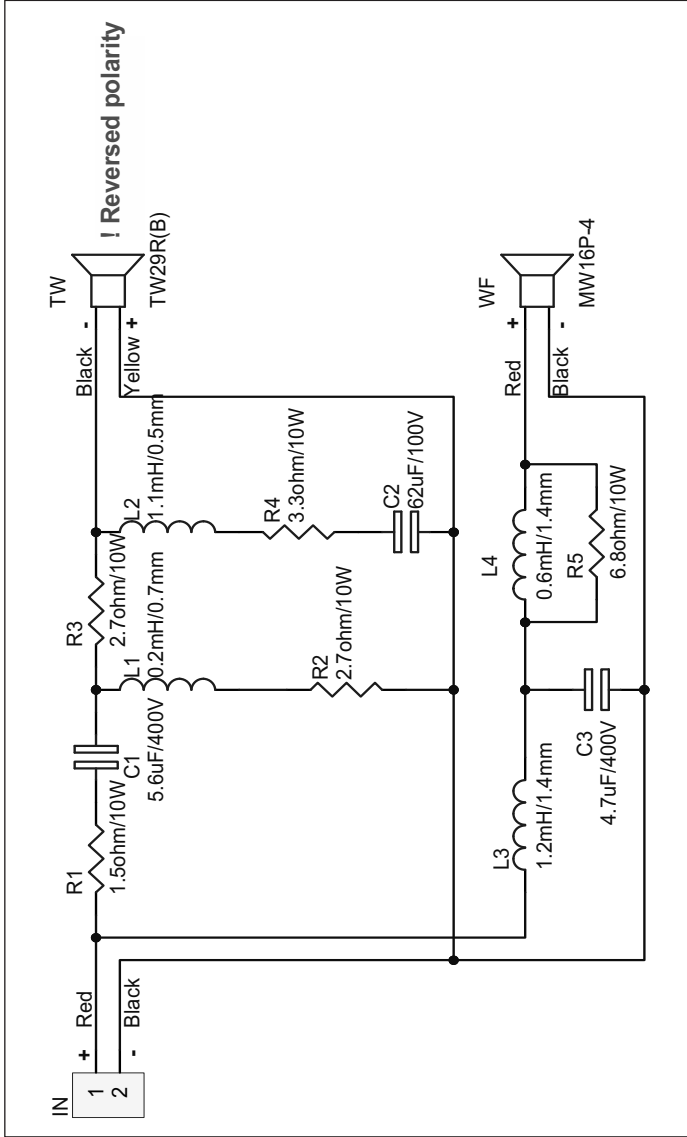

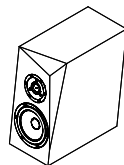

Part List (each cabinet):

- High frequency driver Satori TW29R (sold separately)	1 pc
- Low frequency driver 6½" Satori MW16P-4 (sold separately)	1 pc
- Ara crossover kit (sold separately)	1 pc
- Hex socket screw M4 x 20mm (for drivers)	12 pcs
- Countersunk screw M4 x 20mm (for terminal plate)	4 pcs
- Wood screw 4 x 16 mm for crossover (from crossover kit)	6 pcs
- Insert nut M4 (installed on cabinet)	16 pcs
- Stainless Terminal plate	1 pc
- Binding post	1 pair
- Seal gasket (for terminal plate)	1 pc
- Port flare (installed on cabinet)	1 pc
- Port paper tube (installed on cabinet)	1 pc
- Damping	1 pc
- Name plate	1 pc
- Tweeter grille	1 pc
- Woofer grille	1 pc

Tools Needed:

- Hex key 3mm size (for driver screw).
- Hex key 2.5mm size (for terminal plate screw).
- Philips screwdriver no. 2 (for crossover screw)
- Hot melt glue gun (for attaching the damping and sealing the wire hole).

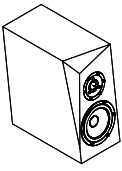

Assembly Instructions:

1. Take out the cabinet from the packaging and take out the raw damping material from the cabinet.



2. Cut the raw damping material to 7 pcs of damping according to the cutting pattern diagram.

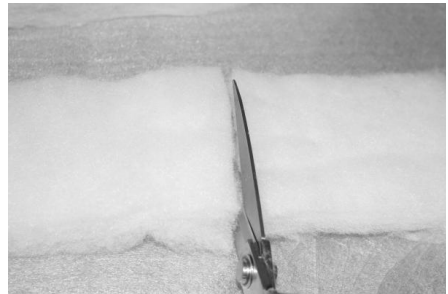

3. Place the crossover on the bottom panel inside the cabinet as shown. Place the two big inductors towards the rear terminal.

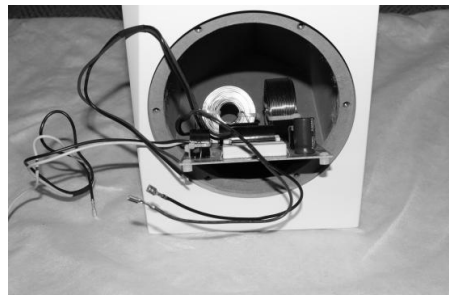

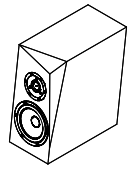

4. Mount the crossover with the 6 screws supplied.



5. Pass the input wire through the hole in the rear panel of the cabinet.

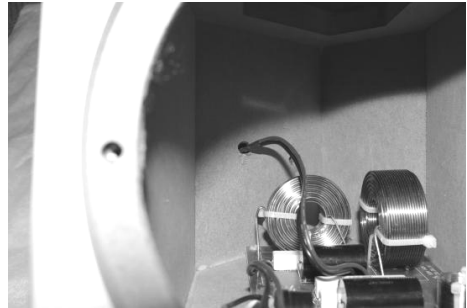

6. Seal the cable hole with hot melt glue.



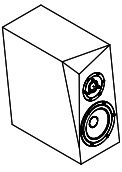

7. Pull the tweeter cable through the hole in cabinet bracing.



8. Place each damping part into the cabinet according to position the diagram. Add a bit of glue if needed to hold the damping material in place

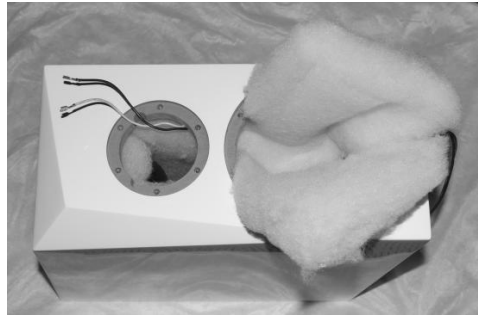

Pass the input cable through the terminal hole on the back of the cabinet, and connect them to the binding posts.



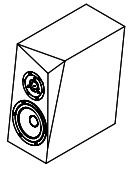

9. Mount the terminal plate to the terminal hole at the back of the cabinet.



10. Hook up the cable to the tweeter and woofer terminals.



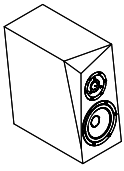

11. Carefully place the drivers in the cabinet and fasten the screws.

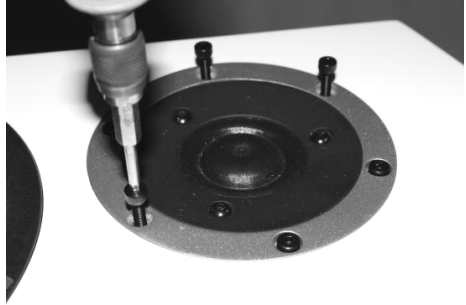

12. Repeat for the other cabinet and your SB ACOUSTICS Ara are now complete. Enjoy!.



Find Us On



www.sbacoustics.com