

Low Power Stereo Series

2 x 15 Watt 8 Ohm Class D Audio Amplifier Board - TPA3110 (AA-AB32996)

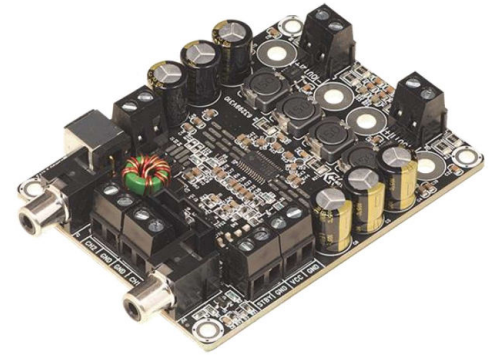

Key Features:

- Output Power
15W@8Ohm 16V DC THD+N 10%
10W@8Ohm 16V DC THD+N 1%
- S.E. / Diff. Input Switchable
- Heat Dissipation through PCB Copper
- Overcurrent Protection
- Overtemperature Protection
- PBTL/BTL mode Switchable
- Weight: 167g/ 0.37 lbs (±10%)
- Size: 3.60 x 2.70 x 0.65 inches

Electrical Specifications

Specifications typical @ +25°C, Powered by 16V DC, unless otherwise noted. Specifications subject to change without notice.

Parameter	Conditions	Min.	Typ.	Max.	Units
Power Supply	-	10	16	24	VDC
Idle Power	SD Floating	-	0.16	0.3	W
Standby Power	SD Connected to GND, FAN OFF	-	0.006	0.1	W
Maximum Current	30W @ 8Ohm	-	2.2	-	A
Efficiency	15W @ 8Ohm	-	87.2	-	%
Minimum Load Impedance	-	-	4.8	-	Ω
Switching Frequency	SD Floating	-	315	-	KHz

Audio Performance

Specifications typical @ +25°C, Powered by 16V DC, unless otherwise noted. Specifications subject to change without notice.

Parameter	Conditions	Min.	Typ.	Max.	Units
Gain	-	24	26	-	dB
Input Sensitivity(RMS)	@8Ω, 15W, 1KHz	-	589	-	mV
Input Impedance	-	-	22	-	KΩ
Output Power	@8Ω THD+N 1% @8Ω THD+N 10%	-	10 15	-	W
Bandwidth @ ±3dB	@8Ω	20	-	20K	Hz
THD	@8Ω, 1W, 1KHz @8Ω, 10W, 1KHz	-	0.0257 0.36	-	%
Output Noise Level	A-weighting, Input Connected to GND	-	114.8	-	μV
SNR	10W @8Ω THD+N 1%	-	94.4	-	dB



All these boards are per-tested with our power supply solution to comply with FCC and CE. For all customers who need those information, please contact our distributor or Sure Electronics. RoHS compliant will need an MOQ of 1000pcs per order.

Ready for:



Contact info

• Email:
info@sure-electronics.com



Typical Performance Graphs

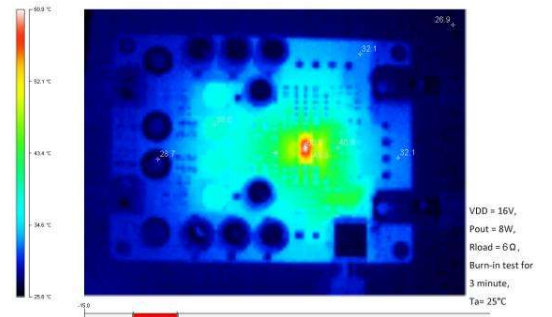
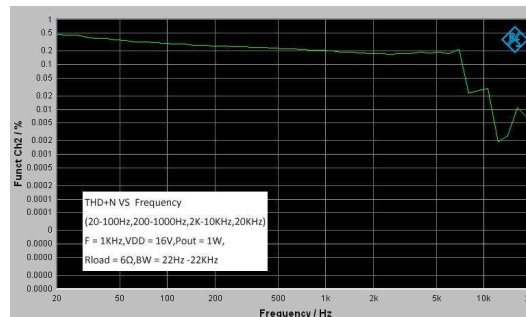
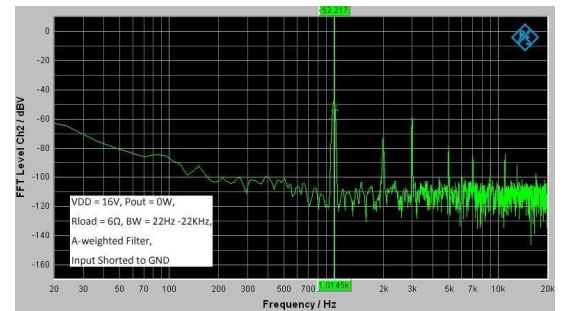
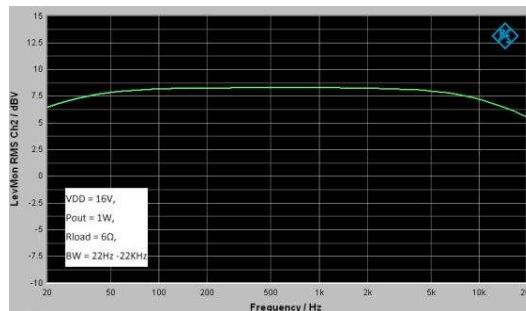

All parameters were tested with Rohde & Schwarz UPV audio analyzer (AES17 filter enabled) and Audio Precision AUX0025 filter. For authorized distributors and OEM customers who need more detailed performance graphs and parameter settings, please send an inquiry e-mail to us. (Not available for retail customers)

Model Selection Guide

Model Number	Output Power	Power Supply	Typical Load	Amplifier IC	Dimension
		Range			
AA-AB32131	2 X 2Watt	DC6-12V	4Ω	PAM8803	3"X2" #1
AA-AB32231	2 X 8Watt	DC8-19V	8Ω	TPA3110	3"X2"
AA-AB32992	2 x 15Watt	DC10-24V	8Ω	MAX9736A	3.6"X2.7" #2
AA-AB32996	2 X 15Watt	DC10-24V	8Ω	TPA3110	3.6"X2.7"
AA-AB32155	2 X 15Watt	DC10-14V	4Ω	TA2024	3.6"X2.7"
AA-AB32254	2 X 20Watt	DC10-28V	8Ω	MAX98400A	3.6"X2.7"
AA-AB32166	2 X 25Watt	DC10-26V	8Ω	TDA7492P	3.6"X2.7"
AA-AB32167	2 X 25Watt	DC10-30V	4Ω	TPA3123	3.6"X2.7"
AA-AB32165	2 X 25Watt	DC14-19V	6Ω	TDA7492	4.8"X3.6" #3

Notes:

- The output power is rated at the condition THD+N 10%, 1kHz sine wave.
- All amplifier boards don't employ power supply reverse polarity protection. Stresses beyond the power supply range maximum ratings may cause permanent damage.
- None typical load may cause rating power reduction.
- Dimensions mean length and width of PCB only, excluding excessive part out of the PCB outline.
- All parameters were tested with Rohde & Schwarz UPV audio analyzer (AES17 filter enabled) and AP AUX0025 filter. Linear Power Supply units were used for testing.
- Sure Electronics promise all standard products life cycle more than 5 years. Sure Electronics reserve the right to update the version without notice. All the products sent to retail customers are the latest version. We will provide back-to-order service (100 Pieces MOQ needed) for our distributors in 5 years.

7. Suggested power supply solution:
 Huntkey HKA03619021-8C 19V 2.1A 40W AC/DC Power Adapter (PS-SP11504)
 If you have other power supply requirements, please feel free to contact us.

Mechanical Dimensions

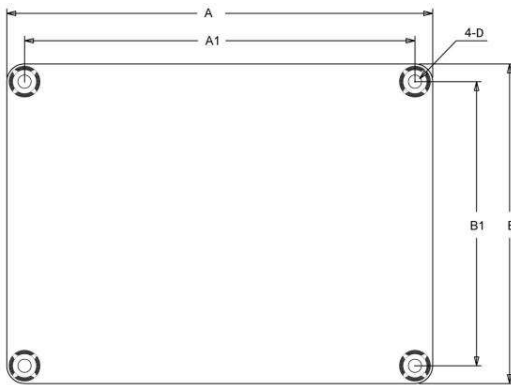

Dimensions	A (inch/mm)	A1 (inch/mm)	B (inch/mm)	B1 (inch/mm)	D (inch/mm)
#1	3.0/76.2	2.7/68.58	2.0/50.8	1.7/43.18	0.12/3.1
#2	3.6/91.44	3.3/83.82	2.7/68.58	2.4/60.96	0.14/3.6
#3	4.80/121.92	4.40/111.76	3.60/91.44	3.20/81.28	0.15/3.8

Notes:

- All dimensions are typical in inches (mm)
 - Tolerance x.xx = ±0.02 (±0.50)
- Height:
 1)AA-AB32178, AA-AB32179: 0.94inch/23.9mm
 2)AA-AB32174:1.53inch/37.5mm
 3)AA-AB32165:0.95inch/24.2mm
 Other models:0.65inch/16.5mm

Connections

This audio amplifier board supports configuration between **mono mode and stereo mode**. It also supports switching of **single-ended input and differential input**. Both are achieved through the DIP switches (SW1) installed on the board. **The default setting is stereo mode with single-ended input.**

BTL / PBTl mode configuration

Mode \ SW Position	1 of SW1
Stereo (BTL)	ON
Mono (PBTl)	OFF

1 of SW1 is for switch between stereo and mono mode.
 When 1 is set at ON, it's stereo mode (default);
 When 1 is set at OFF, it's mono mode.

S.E. / DIFF. input configuration

Input Method \ SW Position	2,3 of SW1
S.E.	ON
DIFF.	OFF

2,3 of SW1 is for switch between single-ended input and differential input.
 When 2,3 are set at ON, it's single-ended input (default);
 When 2,3 is set at OFF, it's differential input.

Stereo mode

Set 1 of SW1 at ON (Default)

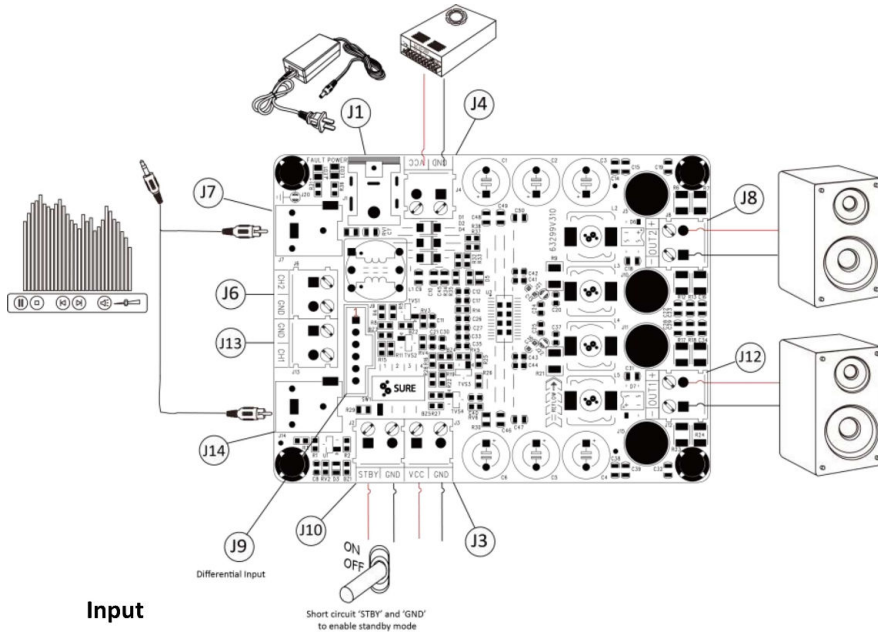

Input

Single-ended input connector:
Set 2,3 of SW1 at ON (Default)
· J14, J7 RCA Jack
· J13, J6 Terminal Block RJ128

	Pin	Function
J13	■	GND
	●	CH1
J6	■	CH2
	●	GND

Differential input connector:
Set 2,3 of SW1 at OFF
· J9

Pin	Function
1	DIFF2-P
2	SGND
3	DIFF2-N
4	DIFF1-P
5	SGND
6	DIFF2-N

Power Supply

Power Adapter Connector:
· J1 DC Jack 5.5mm/2.5mm

Power Supply Connector:
· J3, J4 Terminal Block RJ128

	Pin	Function
J3	■	VCC
	●	GND
J4	■	GND
	●	VCC

Standby Control

Standby Control Connector:
· J10 Terminal Block RJ128

Pin	Function
■	STBY
●	GND

Short circuit 'STBY' and 'GND' to enable standby mode.

Output

Speaker output connector:
· J12, J8 Terminal Block RJ128

	Pin	Function
J12	■	OUT1-
	●	OUT1+
J8	■	OUT2-
	●	OUT2+

Mono mode

Set 1 of SW1 at OFF

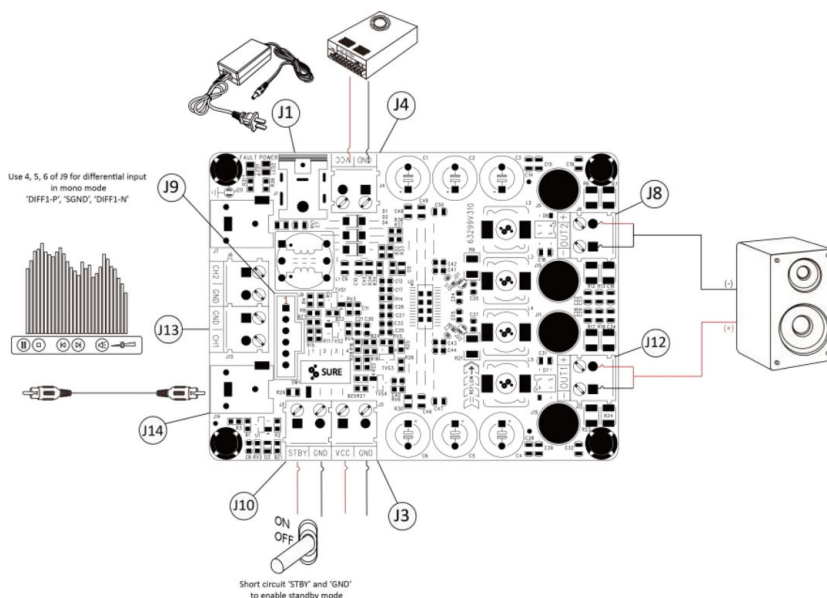

Power Supply

Power Adapter Connector:
· J1 DC Jack 5.5mm/2.5mm

Power Supply Connector:
· J3, J4 Terminal Block RJ128

Standby Control

Standby Control Connector:
· J10 Terminal Block RJ128
Short circuit 'STBY' and 'GND' to enable standby mode.

Input

Single-ended input connector:
Set 2,3 of SW1 at ON (Default)
· J14 RCA Jack
· J13 Terminal Block RJ128

Differential input connector:
Set 2,3 of SW1 at OFF
· J9 Use 4,5,6 only in mono mode

Pin	Function
1	DIFF2-P
2	SGND
3	DIFF2-N
4	DIFF1-P
5	SGND
6	DIFF2-N

Output

Speaker output connector:
· J12, J8 Terminal Block RJ128

	Function
J12	Short circuit as positive of speaker output
J8	Short circuit as negative of speaker output

Short circuit 'OUT1-' and 'OUT1+' as positive of speaker output in mono mode;
Short circuit 'OUT2-' and 'OUT2+' as negative of speaker output in mono mode.



Sure Electronics
Make Your Audio Application Simple!

NO.9, Weidi Road, Xianlin University City, Qixia District,
Nanjing, Jiangsu Province, P.R.C

store.sure-electronics.com

www.wondom.com

Mail: store@sure-electronics.com

Skype: surewebstore